

SYSTEMATIC QUALITY

Technical lights



Catalogue



GIFAS
ELECTRIC

09

Mobile work light

Pages 4-17

FlashLED 2
Battery light



Pages 4-5

TorchLED
Torch light



Pages 6-8

MultiLED 3
Battery lamp



Page 9

Suprabeam
Headlamp



Page 10

Suprabeam
Torch lights



Pages 10-11

Suprabeam
Working lamp



Pages 12-13

Wall and ceiling light

Pages 18-21

StreamLED 2
Wall and ceiling light



Pages 18-20

BetaLUXX
Ceiling light



Page 21

LED spotlight

Pages 23-43

SpotLED FLEX
Workplace lights



Pages 23-24

SpotLED 24
LED spotlight



Pages 25-26

SpotLED 230
LED spotlight



Pages 27-28

ApolloLED 2N
Wide area lighting sys.



Page 29

ApolloLED ECO
Wide area lighting sys.



Page 30

PrimaLED 2
Floodlight



Pages 32-33

Applications

Pages 5, 13, 17, 22, 28, 31, 39

Applications



Pages 5, 13, 22,
28, 31, 39

FlexLED
LED light strip



Page 14-17

AlphaLUXX
LED spotlight



Pages 34-38

DeltaLUXX
LED hall lighting
fixtures



Pages 40-41

HPL
Wide area
lighting system



Pages 42-43

FlashLED 2

work and inspection lamp with emergency light function



IP65



The FlashLED 2 is based on the latest Li-Ion battery technology coupled with up-to-date LED technology.

If the supply voltage of the charging station fails, the light switches on in «emergency light» mode. This is activated at the factory («ON»), but can be changed by pressing the «OFF» switch.

The emergency light function is activated by setting the magnetic switch to the «Emergency Light ON» position.

The swivelling light head is a further advantage; the degree of protection of IP65 (IP54 for the charging station) and the easily understandable film panel are additional positive properties of the product.

Product Features

- The latest Li-Ion technology for a high energy density and maximum service life (up to 1'000 cycles possible)
- GIFAS Battery Management System to monitor and verify all important battery operating parameters
- Up to 14 hours of light depending on the selected operating mode and dimming level:
 - Spot: clustered, wide beam of light
 - Wide: light that illuminates the room
 - Full light: combination of Spot and Wide
 - Emergency light: broadly illuminating light cone
- Memory function = last setting is saved
- Blinking mode
- Robust housing glass fiber reinforced made of polyamide
- Corrosion-resistant charging contacts (spring steel)
- Vertical swivelling light head
- Over-current, temperature and deep discharge protection
- Low self-discharge of the Li-Ion battery

Technical data

Operating voltage: 10 - 42VDC
 Electric power supply: Li-Ion-Akku 14.4V 2'600mAh
 Charging time: 5h
 Luminous period:
 Spot (3 LED): 10h
 Wide (2 LED): 14h
 Full light (5 LED): 5h
Emergency light (5 LED): 5h

Tube:
 Light output: 5 Power-LED à 3W, cool white 5'000K
 Protection category: IP65
 Protection class: III
 Operating temperature range: -20° to +45°C
 Charging temperature range: 0° to +45°C
 Dimensions (WxHxD)
 - Lamp excl. charging station: 252x123x93.4mm
 - Lamp incl. charging station: 323x149x108mm
 Weight: approx. 1.1kg

Charging station

Operating voltage: 230 VAC (85 - 264 VAC) or 12-24 VDC
 Protection category: IP54
 Protection class 230 VAC: II
 Protection class 12 - 24 VDC: III
 Dimensions (WxHxD): 149x276x95mm
 Weight: 430g

Dimensions

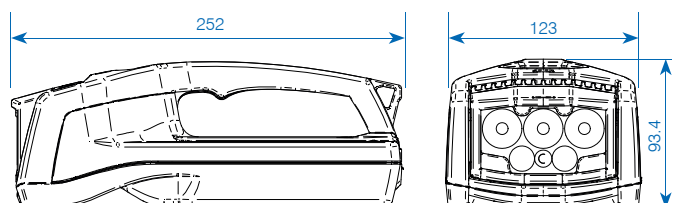

Item no.	Designation
✓ 861200	FlashLED 2 work and inspection lamp with emergency light function without charging station
✓ 860026	FlashLED charging station 230 VAC (85 - 264 VAC), incl. 1.5m cable and plug Euro
✓ 108125	FlashLED charging station BABS 230 VAC (85 - 264 VAC), incl. 1.5m cable and plug Euro
✓ 860027	FlashLED charging station 12 - 24VDC, with plug-in connection, without cable
✓ 860028	Charging cable with cigarette plug, L=2m
✓ 860029	Charging cable for permanent installation, with plug, L=2m

Accessories/spare parts

- ✓ 860030 Shoulder strap for FlashLED
- ✓ 212451 Coloured filter set for FlashLED (red, green, yellow)
- ✓ 861212 Spare battery 14.4V 2'600mAh for FlashLED 2
- ✓ 860744 Battery cover with magnetic strip to FlashLED 2

✓ From stock, offer subject to prior sale

FlashLED 2 charging station 5 fold

FlashLED 2 5-fold charging station



IP20



Complete 5-fold charging station as a wall-mounted model, with integrated power supply 230VAC, 52W incl. connection cable 3m, 3×1 mm², connector T12, fully ready for connection.

Technical Data

Operating voltage:	230 VAC (88 - 264 VAC)
Protection category:	IP20
Protection class:	I
Dimensions (H×W×D)	
– charging station:	149×276×95 mm
– charging station with light:	149×332×106 mm
– 5-fold charging station with light:	760×400×140 mm
Weight	
– light:	approx. 1.1 kg
– charging station:	430 g
– baseplate:	2.8 kg
– baseplate with charging station:	approx. 5 kg
Baseplate:	steel, black powder coated



FlashLED 2 in action



FlashLED 2 in Shoulder strap

Item no.	Designation
✓ 164525	FlashLED 5-fold wall charging station 230 VAC/24 VDC, incl. 3m feed-in cable 3×1.0 mm ² black T12

Dimensions

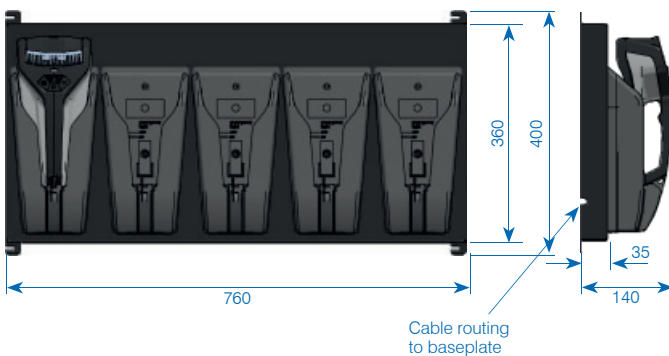

FlashLED 2 in charging station

✓ From stock, offer subject to prior sale

TorchLED torch light



Features

- memory function
- blinking mode (red)
- compact and robust case
- shock- and vibration proof
- state-of-the-art LED technology
- battery or accu operated (can be equipped with standard AA batteries)

Light mode with 1'900mAh batteries/acczs

main functions	functions	operating time	
		battery	accu
1 power LED white	- bright light 100%	approx. 6h	approx. 6h
	- bright light dimmed	> 80h	> 80h
	- broad light 100%	approx. 6h	approx. 6h
	- broad light dimmed	> 80h	> 80h
Signal lights with 2 LED	- permanent	> 40h	> 30h
	- dimmed	> 80h	> 60h

Control element



- A ON/OFF (with memory function)
B Choice of function

Dimensions



✓ From stock, offer subject to prior sale

TorchLED torch light

Battery or accu operated



IP54



Technical data

Power supply:	4 pcs AA 1.5V batteries or 4 pcs AA 1.5V accu cells
Luminous flux:	185lm (2 LED white full light)
Protection category:	IP54
Light source:	LED
Equipment:	2×white/2×red/2×green
Housing:	- PA6-housing, with rubber overmolded handle lots (non-slip) - freestanding - belt clip (chrome steel) - mechanical resistant
Temperature range:	-20°C to +45°C
Dimension (W×H×D):	68×115.5×35mm
Weight:	approx. 115g without cells

Item no.	Designation
✓ 860237*	TorchLED torch light yellow, IP54 incl. hand strap, excl. accu/battery
✓ 860240*	TorchLED torch light yellow, IP54, with magnet incl. hand strap, excl. accu/battery

Accessories/spare parts	
✓ 860274	Accu-NiMH, 1.2V/1'900mAh HR6-AA
✓ 860275	Battery ALKALI, LR& AA 1.5V
✓ 128785	TorchLED wall holder empty, without accessories
✓ 860335	TorchLED belt pouch 12×127×35mm

*For a TorchLED art. 860274 or 860275 is 4×needed.

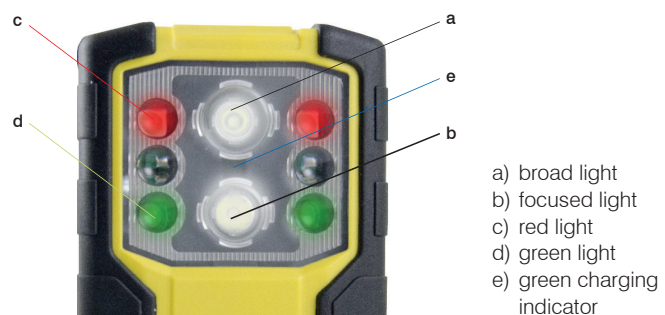

The TorchLED torch light is also available as Ex-version.

TorchLED torch light with emergency light function

Battery operation



6h

IP54



Technical data

Power supply: 4 pcs AA 1.2V accu cells
 Luminous flux: 185lm (2 LED white full light)
 Protection category: IP54
 Light source: LED
 Equipment: 2×white/2×red/2×green
 Housing: – PA6-housing, with rubber overmolded handle lots (non-slip)
 – freestanding
 – belt clip (chrome steel)
 – mechanical resistant

Temperature range: –20°C to +45°C
 Dimension (W×H×D): 68×115.5×35mm
 Weight: approx. 115g without cells

In case of power failure, the light turns on automatically (broadlight 100%, lasting ~ 6 h).

Item no.	Designation
✓ 860236*	TorchLED EMERGENCY torch light, red, IP54 incl. hand strap, excl. accu-NiMH
✓ 860239*	TorchLED EMERGENCY torch light, red, IP54 incl. hand strap and magnetic strip, excl. accu-NiMH

Accessories/spare parts	
✓ 860274	Accu-NiMH, 1.2V/1900mAh HR6-AA
✓ 128785	TorchLED wall holder empty, without accessories

*For a TorchLED torch emergency light with battery, art. 860274 is 4×needed.

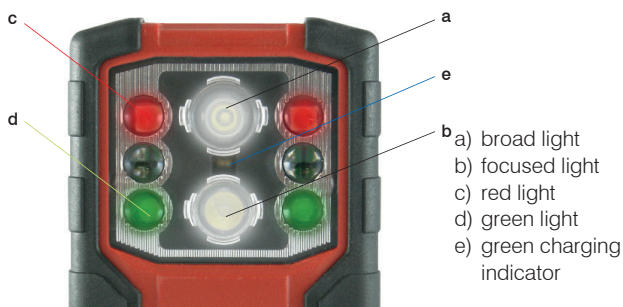

TorchLED torch light Swiss Army

Battery or accu operated



IP54



Technical data

Power supply: 4 pcs. AA 1.5V batteries or 4 pcs. AA 1.2V accu cells
 Luminous flux: 185lm (2 LED white full light)
 Protection category: IP54
 Light source: LED
 Equipment Swiss Army: 2×white/2×red/2×green
 Housing: – PA6-housing, with rubber overmolded handle lots (non-slip)
 – freestanding
 – belt clip (chrome steel)
 – mechanical resistant

Temperature range: –20°C to +45°C
 Dimension (W×H×D): 68×115.5×35mm
 Weight: approx. 115g without cells

Item no.	Designation
✓ 860602*	TorchLED torch light Armee, yellow olive, IP54 incl. hand strap, excl. accu/battery

Accessories/spare parts	
✓ 860274	Accu-NiMH, 1.2V/1900mAh HR6-AA
✓ 860275	Battery ALKALI, LR& AA 1.5V
✓ 128785	TorchLED wall holder empty, without accessories
✓ 860335	TorchLED belt pouch 12×127×35mm
✓ 168655	Magnetic strip for stuck on bracket 20×2×60mm

*For a TorchLED Swiss Army with battery, art. 860274 or 860275 is 4×needed.

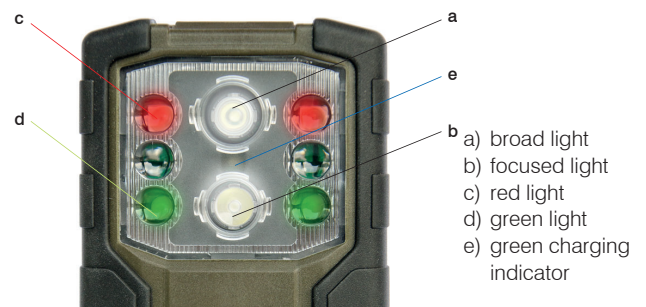

✓ From stock, offer subject to prior sale

TorchLED charging station

for description accu



IP44



Technical data

Operating voltage	100 - 240 VAC / 12 - 48 VDC
Power supply:	700mA charging current
Protection category:	IP44
Protection class:	
– 100 - 240 VAC:	II
– 12 - 48 VDC:	III
Housing:	– ABS
	– wall or table mounting possible
	– lamp retaining clip
Contacts:	spring steel, gold plated
Charging time:	at 1'900mAh cells max. 4h
Temperature range:	0°C to +40°C
Dimension (W×H×D):	
– Charging station:	86.6×79.6×44 mm
– 5-fold charging station:	500×220×125 mm



TorchLED wall charging station 5-fold, Item no.: 130407

IP20



TorchLED Emergency in a construction site cabinet



Applications TorchLED wall charging station 5-fold

Item no.	Designation
✓ 130407	TorchLED 5-fold charging station 100 - 240 VAC / 5 × 700 mA, IP20 incl. 3m lead 3 × 1,0 mm ² black plug T12
✓ 861085	TorchLED charging station, 12 - 48 VDC, IP44 with DC / DC-converter, incl. 1.5m cable with cigarette plug
✓ 860276	TorchLED charging station, 230 VAC / 12 - 48 VDC, IP44, incl. 1.5m cable and Euro plug
✓ 860440	TorchLED charging station 12 - 48 VDC / 700 mA, IP44, with 1.5m cable without plug

✓ From stock, offer subject to prior sale

MultiLED 3

rechargeable battery-operated luminaire with magnet holder



Small, powerful LED spotlight combined with state of the art Li-Ion battery technology.

Technical Data

LED power:	17 W
Luminous flux:	2'000 lm
Electric power supply:	Li-Ion 6.4Ah/7.4VDC
Luminous period	
- Mode 100%:	approx. 5h
- Mode 50%:	approx. 10h
Charging time:	approx. 5h
	Charging indicator with green LED = 100%
Beam angles:	Flood 90°
Protection category:	IP54
Weight incl. accu:	approx. 850 g
Dimensions (L×W×H):	237×120×115 mm
Operating temperature range:	-20° C to +46° C
Charging temperature range:	+10° C to +30° C
Casing:	plastic blue/black rubberised, impact-resistant
Light unit:	aluminum black
Toggle mode:	100%, 50%, flash, off
Additional characteristic features:	Base socket with 4× magnet 50N bracket/suspension bracket pivoting 180° USB socket 5× VDC 2A
Charging unit:	230VAC 50/60Hz IP20 KFZ 12/24VDC / 8.4VDC with cigarette plug optional 5-fold charging adapter 230VAC
Capacity indicator:	
- green:	>65%
- yellow:	25-65%
- red:	10-25%
- red flash:	<10%

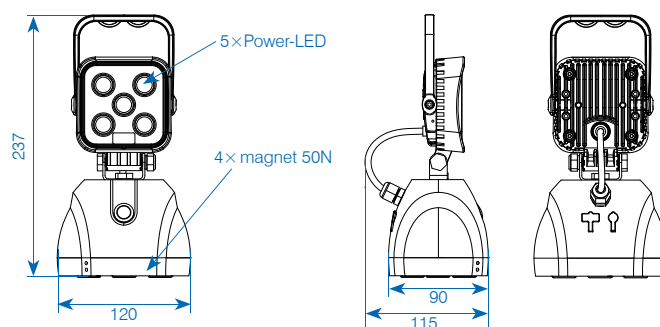

Item no.	Designation
✓ 841113	MultiLED 3 battery light 6.4mAh/7.4V, 17W, 6'500K, incl. charger 230VAC and car adapter
841114	Charger 230VAC
840618	Charger 230VAC 5-fold
841115	Charger 12/24VDC
841117	Spare battery 6.4Ah/7.4VDC

✓ From stock, offer subject to prior sale

Headlamp suprabeam®

Suprabeam S4 rechargeable



Technical Data

Material housing:	Hi-Tech plastic
Headband:	Adjustable to 50 - 70 cm
Weight incl. battery:	136 g
Protection category:	IP68
Operating range of temperature:	-20°C to +35°C
Power source:	Li-Po 1'400mAh
Bright wide:	100 m
Light power levels/luminous period:	
– max:	750lm/5h 30 min
– medium:	250lm/8h
– low:	75lm/18h

Suprabeam V3pro rechargeable



Technical Data

Material housing:	Hi-Tech plastic composite with high strength aluminum
Headband:	Adjustable to 50 - 70 cm
Weight incl. battery:	184 g
Protection category:	IPX4
Operating range of temperature:	-20°C to +50°C
Power source:	Li-Po 2'800mAh
Bright wide:	245 m
Light power levels/luminous period:	
– max:	1'000lm/3h
– medium:	180lm/8h
– dimmung:	6lm - 300lm/max. 225h

Item no.	Designation
✓ 860947	Headlamp LED Suprabeam V3pro rechargeable 1'000lm, incl. 1×Li-Po accu, USB cable
✓ 860707	Headlamp LED Suprabeam S4 rechargeable, 750lm, incl. 1×Li-Po accu, USB cable

Accessories/spare parts

✓ 216788	Spare battery Li-Po for Suprabeam S4 rechargeable
✓ 860709	Spare accumulator Li-Po for Suprabeam V3pro rechargeable
✓ 216790	Helmet Clip for Suprabeam S4 rechargeable
✓ 217308	Helmet Clip-Set for Suprabeam S4 rechargeable
✓ 227473	Silicone headband black for Suprabeam V3pro rechargeable

✓ From stock, offer subject to prior sale

Torch light suprabeam®

Suprabeam Q1r



Technical Data

Material housing:	High strength aluminum, anodised
Dimensions (L×Ø):	141.5mm×15mm
Weight:	48 g
Protection category:	IP20
Operating range of temperature:	-20°C to +50°C
Power source:	1×Li-Po 720mAh
Bright wide:	100 m
Light power levels:	
– max:	550lm
– dimming:	125lm - 6lm
Luminous period:	
– max:	1 h
– low dimming:	50 h

Suprabeam Q3r



Technical Data

Material housing:	High strength aluminum, anodised
Dimensions (L×Ø):	122mm×26.5mm
Weight mit Akku:	130 g
Protection category:	IP68
Operating range of temperature:	-20°C to +50°C
Power source:	Li-Ion 3'000mAh
Bright wide:	200 m
Light power levels:	
– max:	1'100lm
– dimming:	600lm - 6lm
Luminous period:	
– max:	1 h 45 min
– low dimming:	300h

Item no.	Designation
✓ 861241	Torch light LED Suprabeam Q1r 550lm incl. 1×Li-Po accu, USB-C cable
✓ 861242	Torch light LED Suprabeam Q3r, 1'100lm, incl. 1×Li-Ion accu, USB-C cable

Accessories/spare parts

✓ 250023	Spare battery Li-Ion for Suprabeam Q3r
✓ 861244	Signal cone orange for Q3r

Torch light suprabeam®

Suprabeam M6xr



Technical Data

Material housing:	High strength aluminum, anodised
Dimensions (L×Ø):	110 mm×tube 23 mm, head 32 mm
Weight:	114 g
Protection category:	IP68
Operating range of temperature:	-20°C to +50°C
Power source:	Li-Ion 3'000 mAh
Bright wide:	Mixed beam 30°/70°/165 m
Light power levels:	
– max:	2'000 lm
– dimming:	600 lm-6 lm
Luminous period:	
– max:	2 h 15 min
– dimming:	2 h 30 min-260 h

Suprabeam Q3classic



Technical Data

Material housing:	High strength aluminum, anodised
Dimensions (L×Ø):	115.3 mm×26.5 mm
Weight:	96 g
Protection category:	IPX8
Operating range of temperature:	-20°C to +50°C
Power source:	3×AAA
Bright wide:	210 m
Light power levels:	330 lm
Luminous period:	20 h

Item no.	Designation
✓ 860804	Multifunction lamp LED Suprabeam M6xr, 2'000 lm incl. 1×Li-Ion accu, USB-C adapter, headband, quick-release fastener, integrated magnetic base
✓ 860703	Torch light LED Suprabeam Q3classic, 330 lm incl. 3×AAA batteries and belt pouch

Accessories/spare parts	
✓ 860805	Spare battery Li-Ion for Suprabeam M6xr
✓ 861243	Charger 4-fold (set with 4 batteries) for Suprabeam M6xr
✓ 021811	Battery LR03 AAA/1.5V (apiece)

Suprabeam Q5xrs defend



Technical Data

Material housing:	High strength aluminum, anodised
Dimensions (L×Ø):	161 mm×39 mm
Weight:	182 g
Protection category:	IPX4
Operating range of temperature:	-20°C to +35°C
Power source:	Li-Ion 3'300 mAh
Light power levels:	
– max:	2'000 lm
– medium:	400 lm
– low:	50 lm
– strobe:	10 Hz
Luminous period:	
– max:	1 h 15 min
– medium:	3 h 30 min
– low:	28 h

Item no.	Designation
✓ 861099	Torch light LED Suprabeam Q5xrs defend 2'000 lm incl. 1×Li-Ion accu, USB-C cable

Accessories/spare parts	
✓ 861044	Spare battery Li-Ion 3'300 mAh for Suprabeam Q5xrs defend
✓ 860708	Signal cone orange for Q5xrs defend

✓ From stock, offer subject to prior sale

Working lamp suprabeam®

Suprabeam W4r



Item no. 860832

Technical Data

Material housing:	Aluminium, Plastic
Dimensions (L×W×H):	236.6×266×59 mm
Weight:	1'355 g
Protection category:	IP65 /IK07
Operating range of temperature:	-10°C to +40°C
Power source:	Li-Ion 11V, 5'200mAh, 57.2Wh
Colour temperature :	6'500K
Light range:	80 m
Light output levels:	
– high:	4'400 lm
– medium:	2'200 lm
– low:	1'100 lm
Luminous period:	
– high:	1 h 30 min
– medium:	3 h 15 min
– low:	6 h 30 min
Special features:	Operation with cable (230V)/with battery

Suprabeam D4r



Item no. 860831

Technical Data

Material housing:	Plastic
Dimensions (L×W×H):	116×101×41.5 mm
Weight incl. battery:	400 g
Protection category:	IP65 /IK07
Operating range of temperature:	-10°C to +40°C
Power source:	Li-Ion 3.7V, 5'200mAh, 19.24 Wh
Colour temperature :	6'500K
Light range:	
– Flood light:	45 m
– Spot light:	125 m
Light output levels:	
– high:	1'400 lm
– medium:	900 lm
– low:	450 lm
– Spot light:	400 lm
Luminous period:	
– high:	3 h
– medium:	4 h 15 min
– low:	7 h
– Spot light:	6 h 30 min
Special features:	Magnetic bracket

Item no.	Designation
✓ 860832	Working lamp Suprabeam W4r 4'400lm, 1×Li-Ion accu, USB-C adapter
✓ 860831	Working lamp Suprabeam D4r 1'400lm, 1×Li-Ion accu, USB-C adapter

Suprabeam W6r



Item no. 860835

Technical Data

Material housing:	Plastic
Dimensions (L×W×H):	288×176×131 mm
Weight:	2'410 g
Protection category:	IP54 /IK07
Operating range of temperature:	-10°C to +40°C
Power source:	Li-Ion 14.8V, 5'200mAh, 76.96Wh
Colour temperature :	5'700K
Light range:	80 m
Light output levels:	
– max:	4'600 lm
– high:	3'000 lm
– medium:	1'500 lm
– low:	750 lm
Luminous period:	
– max:	2 h 15 min
– high:	3 h 30 min
– medium:	7 h
– low:	14 h
Special features:	– External battery with powerbank function – slewable 180°

Item no.	Designation
✓ 860835	Working lamp Suprabeam W6r 4'600lm, 1×Li-Ion accu, USB-C adapter

Accessories



Item no. 860833

Item no. 860836

Item no. 860834

Accessories/spare parts
✓ 860833 Tripod Suprabeam for W4r/W6r height 0.73 - 1.65m
✓ 860834 Magnet holder Suprabeam for W4r
✓ 860836 Spare battery Li-Ion 5.2Ah 14.8V for Suprabeam W6r

Working lamp suprabeam®

Suprabeam I2r



Item no. 860829

Technical Data

Material housing:	Aluminium, 2K plastic
Dimensions (L×W×H):	220.6×46×66.5 mm
Weight:	373 g
Protection category:	IP54 / IK07
Operating range of temperature:	-10°C to +40°C
Power source:	Li-Ion 3.7V, 2'600 mAh, 9.62 Wh
Colour temperature :	6'500 K
Light output levels:	
– Top light:	120 lm
– dimming:	700 - 60 lm
Luminous period:	
– Top light:	10 h
– dimming:	2 - 16 h
Special features:	– hook – magnetic foot

Item no.	Designation
✓ 860829	Working lamp Suprabeam I2r 700lm, 1×Li-Ion accu, USB-C adapter

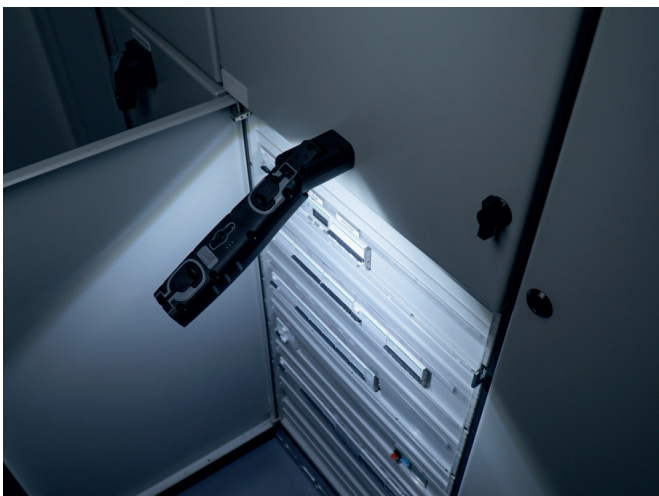

FlexLED – 2-sided LED light strip on cable reel or reel



Our FlexLED LED light strip not only enables you to save energy when using temporary lighting installations but also an enormous amount of time as a result of the easy set-up and disassembly. This LED light strip is covered by a durable PVC tube and guarantees absolute flexibility and an extremely high light output without casting shadows. The protection category of IP65 means that it can be used indoors and outdoors. The mains connection is made using the supplied connection cable. The FlexLED light stripe can be connected quickly and easily and thus be extended to a maximum length of 100m.

Product features

The LED stripe 2-sided is supplied ready for connection with **25 meters on a cable reel or 5 resp. 10 meters on reel unit.**

Technical Data

LED:	LED strip double-sided (2×180 LEDs/m)
System performance:	13W/m (10W/m*)
Light efficiency:	1'500lm/m (1'300lm/m*)
Light colours:	white 3'000K/4'000K, red, green, blue
Beam angles:	240° (120° per side)
Operating life:	> 30'000h
Protection category:	IP65
Impact resistance:	IK10
Operating temperature range:	-20°C to +50°C
Weight reel with	
– 5m:	approx. 1.2kg
– 10m:	approx. 2.3kg
Weight cable reel with 25m:	approx. 6.2kg
Dimensions light strip (L×W):	16×8mm
Length:	5m/10m/25m (extendable to max. 100m)
Connection cable:	1.5m 2×1.5mm ² rubber cable with CH-plug IP55 type 11

Item no.	Designation
✓ 861055	FlexLED on a reel 10m, 3'000K, Wide 240°
✓ 861054	FlexLED on a reel 10m, 4'000K, Wide 240°
✓ 861049	FlexLED on cable reel 25m, 3'000K, Wide 240°
✓ 861022	FlexLED on cable reel 25m, 4'000K, Wide 240°
✓ 861235	FlexLED on reel 5m, red, Wide 240°
✓ 861236	FlexLED on reel 5m, green, Wide 240°
✓ 861237	FlexLED on reel 5m, blue, Wide 240°
✓ 256786	Pipe clamp PP black for outer-ø 15mm
✓ 861086	Connection cable CH-plug type 11
✓ 861254	Power supply 400W, IP65, flicker-free, with plug type 13 (FlexLED output 10W/m, 1'300lm/m)
✓ 251254	Extension cable 5m 2×1.5mm ²
✓ 251253	T-connector
✓ 861098	Dimmer with plug type 11



* flicker-free in combination with power supply unit (art. no. 861254)

Strictly observe the operating instructions included with the products!

✓ From stock, offer subject to prior sale

FlexLED – LED light strip on cable reel or reel

FlexLED – one-sided LED light strip on reel



Our FlexLED LED light strip not only enables you to save energy when using temporary lighting installations but also an enormous amount of time as a result of the easy set-up and disassembly. This LED light strip is covered by a durable PVC tube and guarantees absolute flexibility and an extremely high light output without casting shadows. The protection category of IP65 means that it can be used indoors and outdoors. The mains connection is made using the supplied connection cable. The FlexLED light stripe can be connected quickly and easily and thus be extended to a maximum length of 100m.

Product features

The LED stripe one-sided is supplied ready for connection with **25 meters on reel**.

Technical Data

LED:	LED strip one-sided (180 LEDs/m)
System performance:	12W/m (10W/m*)
Light efficiency:	1'500lm/m (1'300lm/m*)
Light colour:	3'000K/4'000K
Beam angles:	120° one-sided
Operating life:	> 30'000h
Protection category:	IP65
Impact resistance:	IK10
Operating temperature range:	-20°C to +50°C
Weight reel with 25m:	4 kg approx.
Dimensions light strip (L×W):	16×8mm
Length:	25m (extendable to max. 100m)
Connection cable:	1.5m 2×1.5mm ² rubber cable with CH-plug IP55 type 11

* flicker-free in combination with power supply unit (art. no. 861254)

Item no.	Designation
✓ 861207	FlexLED on a reel 25m, 3'000K, Wide 120°
✓ 861206	FlexLED on a reel 25m, 4'000K, Wide 120°
✓ 244658	Fastening set (50 clips/100 screws)
✓ 256786	Pipe clamp PP black for outer-ø 15 mm
✓ 861086	Connection cable CH-plug type 11
✓ 861254	Power supply 400W, IP65, flicker-free, with plug type 13 (FlexLED output 10W/m, 1'300lm/m)
✓ 251254	Extension cable 5m 2×1.5mm ²
✓ 251253	T-connector
✓ 861098	Dimmer with plug type 11



Strictly observe the operating instructions included with the products!

✓ From stock, offer subject to prior sale

FlexLED – Emergency battery pack (optional)



Product features

The FlexLED can continue to be operated with reduced brightness for up to a maximum of 2 hours with the emergency battery pack in the event of a power failure.

The battery charge level can be displayed by actuating the light.

It has an internally built-in battery charge protection with protection against overcharging and deep discharge.

The emergency battery pack is supplied with an IP55 Type 13 plug and connector.



Technical Data

Output:	50W
Emergency operation rechargeable battery:	120min
Battery level:	Display via indicator light
Connected power:	max. 1'500W
Input voltage:	100-277V AC
Output voltage:	175DC
Battery:	22.2V 6'000mAh Li-Ion battery
Charging time:	> 8h (80%)
Emergency trigger time:	<1s
Protection category:	IP65
Impact resistance:	IK08
Temperature range:	-10°C to +45°C
Connection cable:	1.5m 3×1.5mm ² rubber cable with plug and connector IP55 type 13

Emergency operation brightness one-sided LED light strip:

25m:	20%	300lm/m
50m:	10%	150lm/m

Emergency operation brightness 2-sided LED light strip:

10m:	30%	450lm/m
25m:	20%	300lm/m
50m:	10%	150lm/m

Battery status query:

With the emergency function switched on, briefly press the illuminated pushbutton to indicate the power supply.

Number of red light flashes (flashing):

1×	=	0% – 20%	remaining power
2×	=	20% – 40%	remaining power
3×	=	40% – 60%	remaining power
4×	=	60% – 80%	remaining power
5×	=	80% – 100%	remaining power



Item no.	Designation
✓ 861052	FlexLED emergency battery pack



Dam wall Grande-Dixence



Christmas market Fiastenu



Roof lighting



Implenia Switzerland, ARGE Gotthard

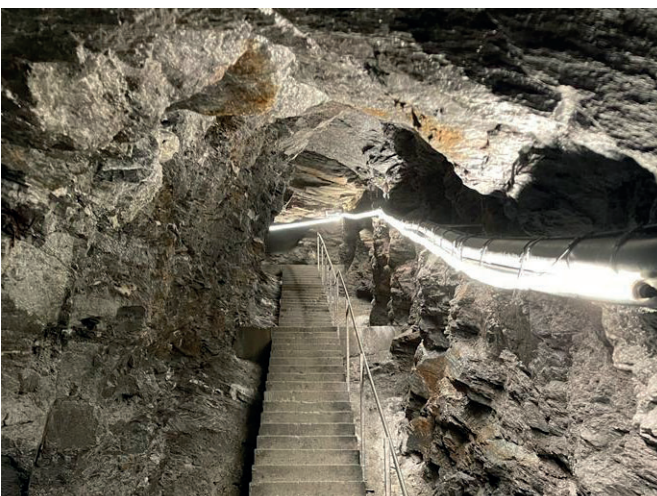

Zermatt tunnel



Construction site Bitsch VS

StreamLED 2

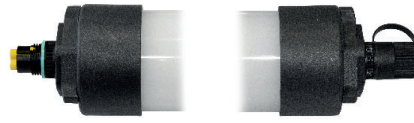

Pluggable

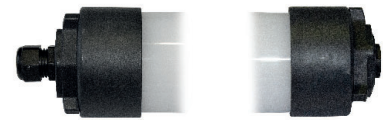

Direct connection



Technical Data

Input voltage:	198-264 VAC (176-264 VDC)
System performance:	20W/35W/55W
Luminous flux:	2'121 lm/4'245 lm/7'102 lm
Light efficiency:	106 lm/W/121 lm/W/129 lm/W
Colour temperature:	4'000K/5'000K (3'000K on request)
Incide of CRI:	Ra > 80
Beam angles LED:	120°
Operating life:	L70 B10 > 50'000h
Protection category:	
- direct connection:	IP66/IP69
- direct connection*:	IP67
- pluggable:	IP66
Impact resistance:	
- direct connection:	IK10
- pluggable:	IK08
Protection class:	II
Operating range of temperature:	-25°C to +40°C
Material housing / tube:	PMMA acrylic glass
Weight:	2.07 kg/3.20 kg/4.34 kg
Housing colour:	cover cap anthracite RAL7016/ tube transparent frosted (satinised)

*IP67: For temporary immersion, protected with moulded end caps and moulded connection cable

Product features

- high efficiency and uniformity of illuminance
- robust and impact-proof
- energy-saving (low power/energy consumption with high light power)
- easy installation
- wide range of products
- suitable for use in the harshest environments (tunnels, sewage treatment plants, chemical industry)
- plug-in design or with screwed cable glands for direct connection
- through-wiring available for all models

Dimensions

StreamLED 2 – pluggable

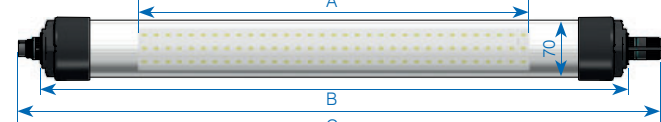

StreamLED 2 – direct connection

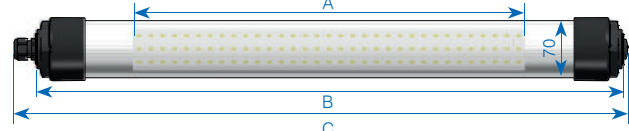

StreamLED 2 – pluggable

	Item no.	Output	Illuminant	Luminous flux	Light colour	Operating voltage	A mm	B mm	C mm
✓	860660	20W	LED	2'121 lm	4'000K	230 VAC	479	719	786
✓	860661	20W	LED	2'121 lm	5'000K	230 VAC	479	719	786
✓	860662	35W	LED	4'245 lm	4'000K	230 VAC	958	1'198	1'265
✓	860663	35W	LED	4'245 lm	5'000K	230 VAC	958	1'198	1'265
✓	860664	55W	LED	7'102 lm	4'000K	230 VAC	1'437	1'677	1'744
✓	860665	55W	LED	7'102 lm	5'000K	230 VAC	1'437	1'677	1'744

StreamLED 2 – direct connection

	Item no.	Output	Illuminant	Luminous flux	Light colour	Operating voltage	A mm	B mm	C mm
✓	860666	20W	LED	2'121 lm	4'000K	230 VAC	479	719	751
✓	860667	20W	LED	2'121 lm	5'000K	230 VAC	479	719	751
✓	860668	35W	LED	4'245 lm	4'000K	230 VAC	958	1'198	1'230
✓	860669	35W	LED	4'245 lm	5'000K	230 VAC	958	1'198	1'230
✓	860670	55W	LED	7'102 lm	4'000K	230 VAC	1'437	1'677	1'709
✓	860671	55W	LED	7'102 lm	5'000K	230 VAC	1'437	1'677	1'709

*The overall size is increased by approx. 20mm in the chain design (cable on each side). The cover cap is included in the scope of supply.

✓ From stock, offer subject to prior sale

StreamLED 2 DALI



with cable gland and connection cable 30 cm



Technical Data

Input voltage:	230 VAC
System performance:	35 W/55 W
Luminous flux:	3'997 lm/6'730 lm
Light efficiency:	113 lm/W/123 lm/W
Incide of CRI:	Ra > 80
operating life:	L70 B10 > 50'000 h
Protection category:	
– direct connection:	IP66 /IP69
– direct connection*:	IP67
Impact resistance:	
– direct connection:	IK10
Protection class:	II
Operating range of temperature:	-25°C to +40°C
Colour temperature:	3'000K/4'000K/5'000K
Beam angles LED:	120°
Material housing / tube:	PMMA acrylic glass cover cap anthracite RAL7016/ tube transparent frosted (satinised)
Housing colour:	

*IP67: For temporary immersion, protected with moulded end caps and moulded connection cable

Product features

- high efficiency and uniformity of illuminance
- robust and impact-proof
- energy-saving (low power/energy consumption with high light power)
- easy installation
- wide range of products
- suitable for use in the harshest environments (tunnels, sewage treatment plants, chemical industry)
- version single-sided with connection cable 30 cm (5 poles)
- through-wiring available for all models

Dimensions

StreamLED 2 DALI with connection cable 30 cm

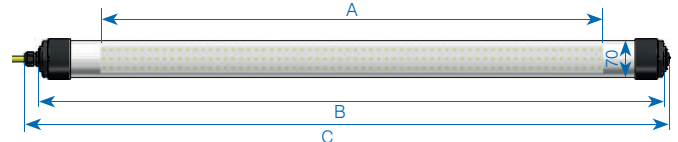

StreamLED 2 – DALI

Item no.	Output	Illuminant	DALI	Luminous flux	Light colour	Operating voltage	A mm	B mm	C mm
860902	35 W	LED	1	3'997 lm	3'000 K	230 VAC	958	1'198	1'230
✓ 860904	35 W	LED	1	3'997 lm	4'000 K	230 VAC	958	1'198	1'230
✓ 860906	35 W	LED	1	3'997 lm	5'000 K	230 VAC	958	1'198	1'230
860903	55 W	LED	2	6'730 lm	3'000 K	230 VAC	1'437	1'677	1'709
✓ 860905	55 W	LED	2	6'730 lm	4'000 K	230 VAC	1'437	1'677	1'709
✓ 860907	55 W	LED	2	6'730 lm	5'000 K	230 VAC	1'437	1'677	1'709

*The overall size is increased by approx. 20mm in the chain design (cable on each side). The cover cap is included in the scope of supply.

✓ From stock, offer subject to prior sale

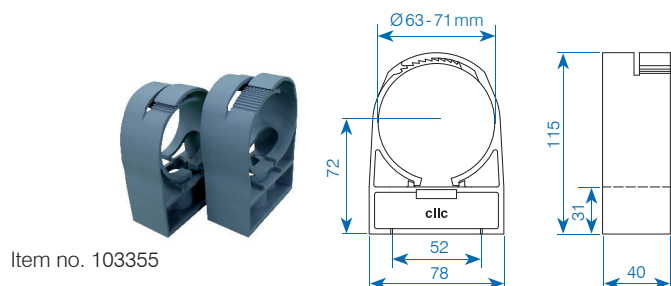
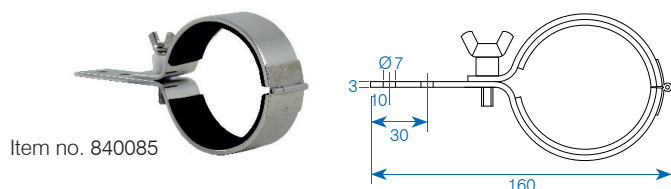
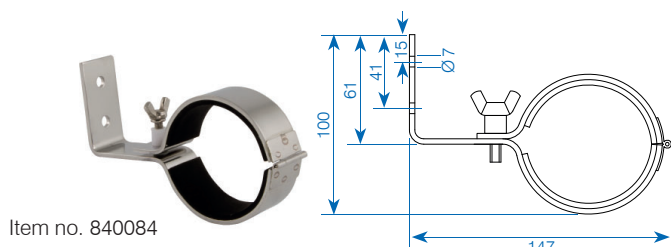
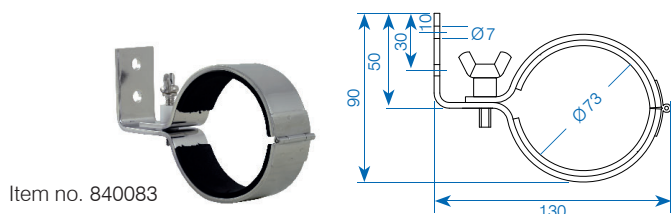

Accessories/spare parts	
✓ 185329	BetaLUXX/StreamLED 2 extension cable 2×1.5 mm ² , L=2.5 m, incl. plug and connector
✓ 188951	BetaLUXX/StreamLED 2 extension cable 2×1.5 mm ² , L=3 m, incl. plug and connector
✓ 188952	BetaLUXX/StreamLED 2 extension cable 2×1.5 mm ² , L=5 m, incl. plug and connector
✓ 187542	BetaLUXX/StreamLED 2 connection cable 2×1.5 mm ² , L=5 m, incl. plug T12 and connector
✓ 860481	BetaLUXX/StreamLED 2 connection cable 2×1.5 mm ² , L= 2.5 m single-sided with connector
✓ 860482	BetaLUXX/StreamLED 2 connection cable 2×1.5 mm ² , L= 5 m, single-sided with connector
✓ 183681	Plug 2P, 17.5 A, 250 VAC, IP68 for cable Ø7-12 mm
✓ 183680	Connector 2P, 17.5 A, 250 VAC, IP68 for cable Ø7-12 mm
✓ 036791	Cable H07RNF, 2×1.5 mm ² , black, Ø11 mm
✓ 840083	Holder A4, Ø70 mm/wall mounting, angled 130 mm
✓ 840084	Holder A4, Ø70 mm/wall mounting, angled 147 mm
✓ 840085	Holder A4, Ø70 mm/attachment fitting straight, 160 mm
✓ 103355	Clamp plastic, Ø63-71 mm
✓ 136624	Cover cap, with cable gland M20×1.5 mm, plastic anthracite
✓ 148225	Cover cap, with locking device M20×1.5 mm, plastic anthracite

BetaLUXX

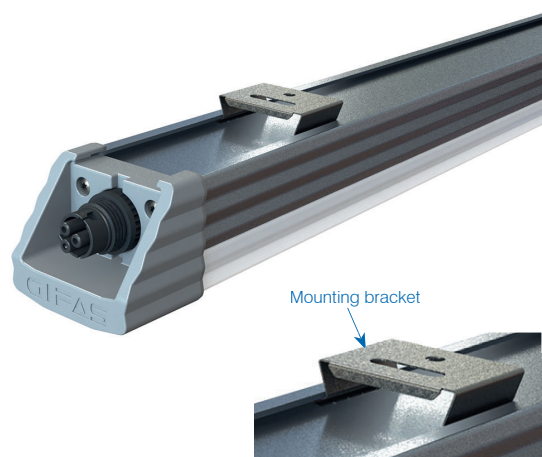
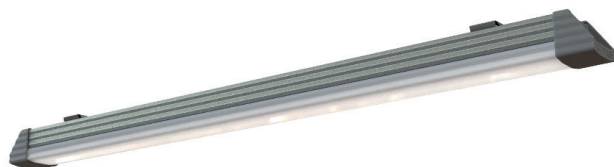

The LED ceiling light BetaLUXX is extremely robust with a high protection class of IP66. Because of the satinised glass the glare can be minimised but still guaranteeing an equal light distribution. The supplied mounting clips simplify installation. Because of this characteristics the BetaLUXX is versatile for utilisation in the industry and other fields harsh environments.

Technical Data

Voltage:	198-264 VAC (176-264 VDC)
LED power:	20W/35W/55W
Luminous flux:	1'964 lm/3'929 lm/6'574 lm
Light efficiency LED:	98.2 lm/W/112 lm/W/120 lm/W
Colour rendering index:	Ra > 80
Operating life LED:	L70/B10 > 50'000 h
Protection category:	IP66
Impact resistance:	IK10
Protection class:	II
Operating range of temperature:	-25°C to +40°C
Colour temperature:	3'000K/4'000K/5'000K
Beam angles:	120°
Material housing:	Aluminium
Housing colour:	grey
Cover:	polycarbonate UV resistance, halogen-free

Weight:

- 20:	1'190g
- 40:	2'024g
- 60:	2'857g

Dimensions H×L×W:

- 20:	570×69.3×59.6 mm
- 40:	1'046×69.3×59.6 mm
- 60:	1'524×69.3×59.6 mm

Input voltage:

Connection cable
(not included with the lighting fixture)

BetaLUXX complete with plug and connector

	3'000K	4'000K	5'000K	Designation
✓	860627	✓ 860626	✓ 860616	BetaLUXX 20, 230 VAC, 1'964 lm
✓	860628	✓ 860614	✓ 860470	BetaLUXX 40, 230 VAC, 3'929 lm
✓	860629	✓ 860615	✓ 860480	BetaLUXX 60, 230 VAC, 6'574 lm
			✓ 860645	BetaLUXX 40, 230 VAC, 3'929 lm for International Food Standard

Features

- high efficiency and uniformity of illuminance
- robust
- power-saving (low power / energy consumption with high light power)
- easy mounting with mounting clip (included in delivery)
- stainless spring steel (1.4301) mounting bracket
- pluggable
- with feed-through wiring

Dimensions

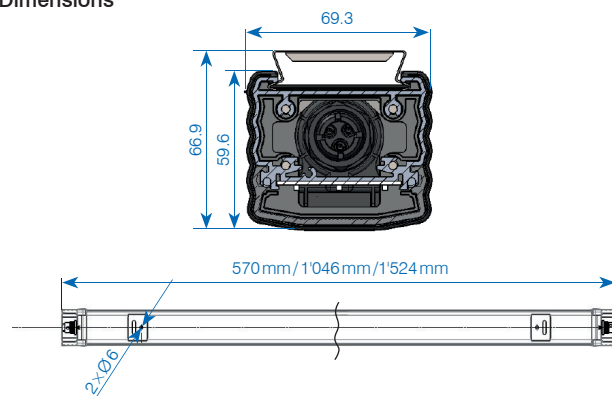

Accessories/spare parts

✓	185329	BetaLUXX / StreamLED 2 extension cable 2×1.5 mm ² , L=2.5 m, incl. plug and connector
✓	188951	BetaLUXX / StreamLED 2 extension cable 2×1.5 mm ² , L=3 m, incl. plug and connector
✓	188952	BetaLUXX / StreamLED 2 extension cable 2×1.5 mm ² , L=5 m, incl. plug and connector
✓	187542	BetaLUXX / StreamLED 2 connection cable 2×1.5 mm ² , L=5 m, incl. plug T12 and connector
✓	860481	BetaLUXX / StreamLED 2 connection cable 2.5 m 2×1.5 mm ² single-sided with connector
✓	860482	BetaLUXX / StreamLED 2 connection cable 5 m 2×1.5 mm ² single-sided with connector
✓	183681	Plug 2P, 17.5 A, 250 VAC, IP68, for cable Ø7-12 mm
✓	183680	Connector 2P, 17.5 A, 250 VAC, IP68, for cable Ø7-12 mm
✓	036791	Cable H07RNF, 2×1.5 mm ² , black, Ø11 mm
✓	860632	BetaLUXX mounting bracket with screw locking for vertical mounting (2 piece per light)

✓ From stock, offer subject to prior sale

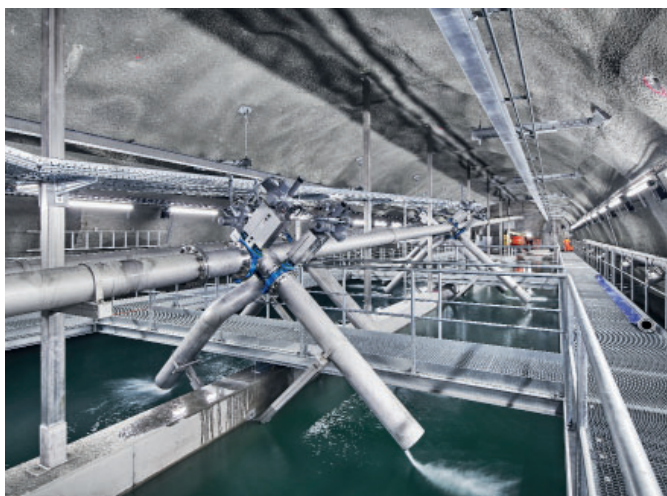

StreamLED 2: Customer / installation engineer: BLS Netz AG
EPRO TRAFFIC GmbH: Electrical engineer



StreamLED 2



BetaLUX



BetaLUX



BetaLUX



BetaLUX

SpotLED FLEX Workplace light



SpotLED with flex hose 200 mm

IP54



SpotLED with flex hose 400 mm

IP54



The work lamp SpotLED FLEX proves for a good view in every situation, it is a highly effective, small and compact light source. This lamp provides light as needed, safe and comfortable. Thanks to latest LED technology, SpotLED FLEX is a very energy-efficient, long lasting lighting in commercial, industrial and indoor and outdoor areas.

The SpotLED FLEX is extremely robust, can be rotated and turned and offers therefore a wide variety of applications for the right light.

Our standard range includes lengths of 300 mm to 600 mm, but obviously we are manufacturing also other models, concerning optics, light colour, length of flex hose (on request).

We also offer a wide assortment of accessories, from magnetic clamp right up to the protective grid.

Features

- small spotlight in modern design
- brackets made of stainless steel V2A, powder-coated
- thanks to vibration-proof LED technology, the maintenance costs are lower than with conventional lighting

Technical Data

Operating voltage:	230 VAC
Power consumption:	115 mA
Lamps:	5 PowerLED à 3W
Light temperature:	6'000K (cool white)
Beam Angles:	Spot/Medium
Protection category:	IP54 (without plug-in power pack)
Protection class:	III
Surface temperature:	max. +55° C
Temperature range:	-30° C up to +45° C
Material housing:	made of die cast aluminum, black coated
Material flex hose:	steel, black coated
Material adapter:	steel, black coated
Connection cable:	1.8m, 2x0.5 mm ² (PUR-cable)

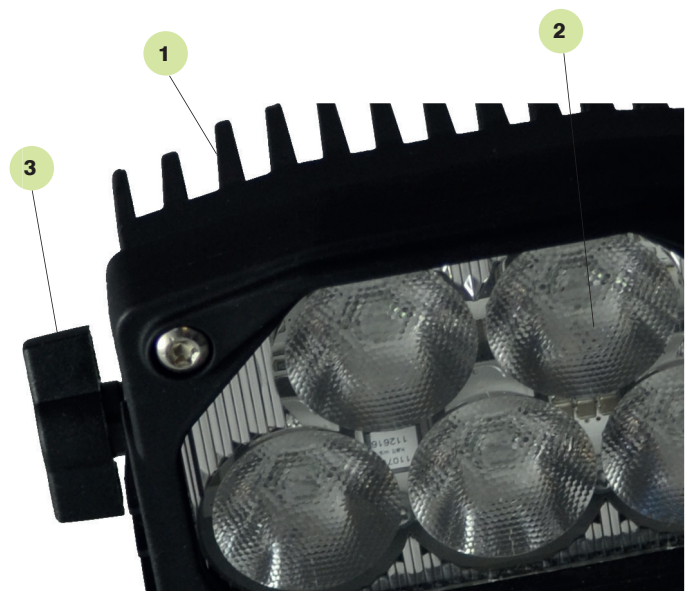

- 1 Housing with cooling fins: for optimum cooling
- 2 LED
- 3 Locking screw
- 4 Flex hose
- 5 On/Off
- 6 Power supply 230VAC/18VDC



SpotLED FLEX - Spot

Lighting scheme

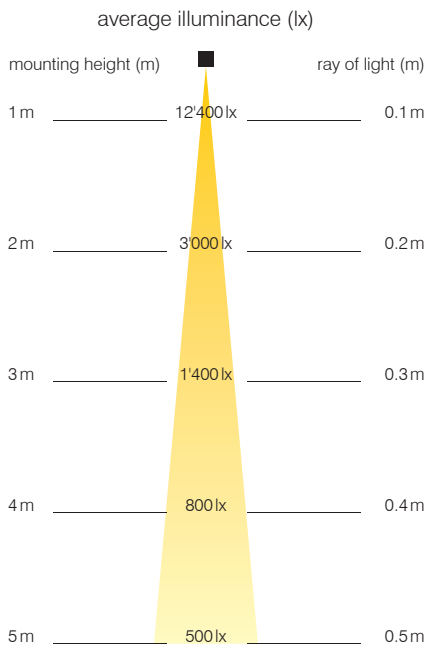

SpotLED FLEX - Medium

Lighting scheme

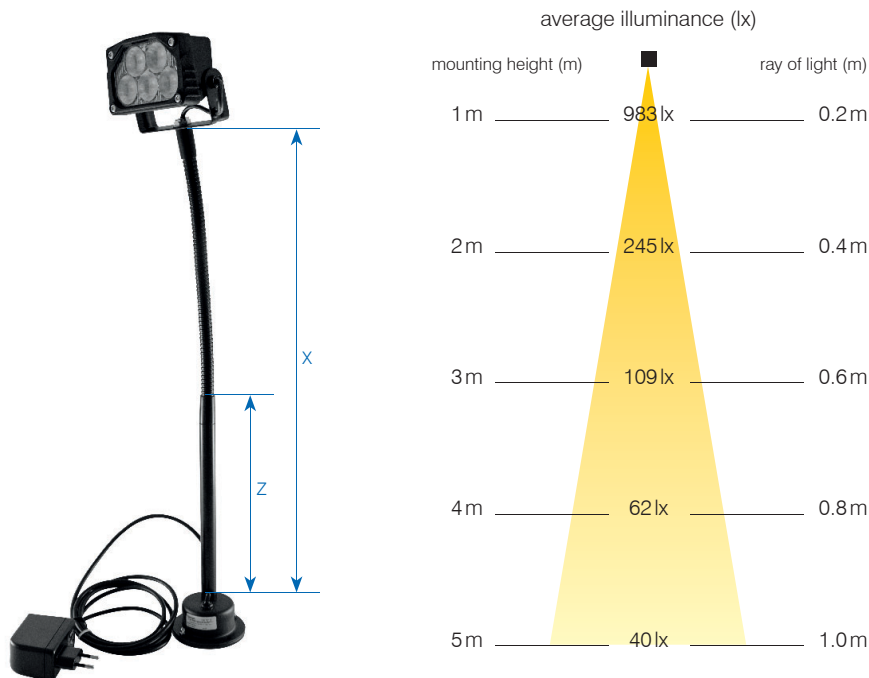

Our standard range Spot

SpotLED FLEX black, cool white, cable 1.8 m, plug-in power pack 230 VAC / 18 VDC

Item no.	length mm (X)	this adapter mm (Z)	flex hose mm (Ø)
116285	300 mm	-	14 mm
116287	400 mm	-	14 mm
117613	500 mm	200 mm	14 mm
116295	600 mm	-	15 mm

Other models and types on request.

Our standard range Medium

SpotLED FLEX black, cool white, cable 1.8 m, plug-in power pack 230 VAC / 18 VDC

Item no.	length mm (X)	this adapter mm (Z)	flex hose mm (Ø)
✓ 116284	300 mm	-	14 mm
✓ 116286	400 mm	-	14 mm
117611	500 mm	200 mm	14 mm
✓ 116294	600 mm	-	15 mm

Other models and types on request.

Accessories/spare parts		
✓ 110427	Plug-in power pack 230 VAC / 18 VDC, 1'200 mA incl. connection cable 1.8 m, black	
✓ 024315	Magnetic clamp black ø 86 / 20 mm, with bore ø 6,5 mm, force = 540 N	
✓ 104508	Protective glass (cover) polycarbonate	
✓ 104431	Protective grid V2A	
✓ 109212	Wing screw plastic M5 × 10 mm	



✓ From stock, offer subject to prior sale

SpotLED 24



IP67



The high-performing and energy-efficient SpotLED spotlights with state-of-the-art LED-technology offer a wide range of applications for interior and exterior lighting.

The housing material (cast aluminium) can be individually combined with the other components (LED, optics, colours) and can be used for a wide variety of lighting purposes.

Whether used outdoors on transportation or work vehicles (construction, agriculture, cleaning, waste disposal, snow cats) or in the garden and on storefronts – the SpotLED puts things in the right light.

There are also many applications for indoor lighting for rooms and work-spaces.

Features

- small spotlight in modern design
- housing made of die cast aluminum
- available in two housing colours: silver and black
- brackets made of stainless steel V2A, powder-coated
- light source: 5 Power-LED
- various beam angles (different optics)
- works perfect even at low temperatures, no flickering
- dimming with potentiometer possible (500kOhm positive logarithmic)
- thanks to vibration-proof LED technology, the maintenance costs are lower than with conventional lighting

Technical Data

Operating voltage:	12-30VDC, (24VAC upon request)
Power consumption:	500mA @ 24VDC, 950mA @ 12VDC
Lamps:	5 Power LED
System performance:	10W
Luminous flux:	750lm
Light colours:	warm white 3'000K cool white 6'000K
Protection category:	IP67
Protection class:	III
Surface temperature:	max. 55°C
Temperature range:	-30°C to +45°C
Weight:	348g



Set up SpotLED

1. Housing
2. Optics
3. Mounting bracket
4. Power-LED
5. Safety glass

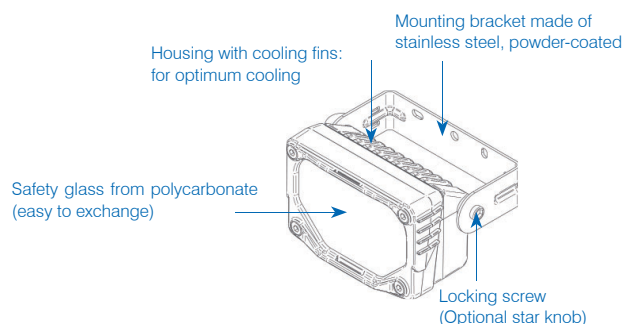
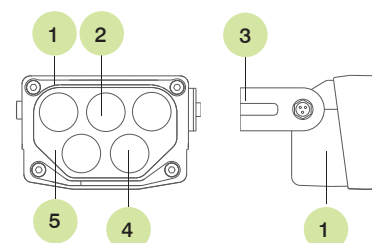

Dimensions

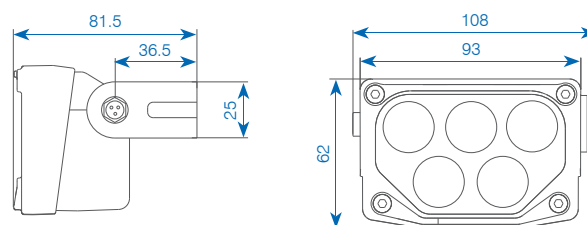

Connection diagram

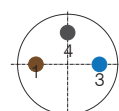

- 1 = brown (Wire number 1) + 24VDC
 3 = blue (Wire number 3) optional connection for «dimmer»
 4 = black (Wire number 2) - 24VDC

SpotLED with fixed connection

Cable PUR 3×0.25 mm², black, length 5m, 2nd page unedited

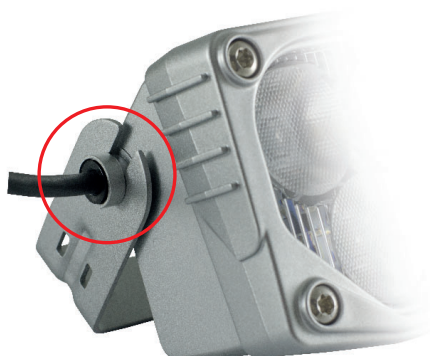

SpotLED with built-in connector IP67



	Item no. Cool white	Item no. Warm white	Version SpotLED	Housing Colour	Optics
✓	131064	131068	Wide	silver	5×67°
	131065	131069	Wide	black	5×67°
✓	039636	104967	Medium	silver	5×38°
✓	039637	104970	Medium	black	5×38°
✓	039643	104976	Spot	silver	5×10°
✓	039644	104977	Spot	black	5×10°

	Item no. Cool white	Item no. Warm white	Version SpotLED	Housing Colour	Optics
	131040	131044	Wide	silver	5×67°
✓	131041	131045	Wide	black	5×67°
	038015	101867	Medium	silver	5×38°
✓	038016	✓ 101868	Medium	black	5×38°
	038021	101873	Spot	silver	5×10°
✓	038022	101874	Spot	black	5×10°

Accessories/spare parts/spare



Item no. 152996



Item no. 101068



Item no. 109212



Item no. 860031



Item no. 101069



Item no. 104431

Item no.	Designation
✓ 104508	Transparent cover polycarbonate transparent
✓ 152996	Spare glass (assembly) polycarbonate for light unit SpotLED 24
✓ 104431	Protective grid V2A, for SpotLED
✓ 860031	Coloured filter for SpotLED set with 3 pcs.: green, red, yellow
✓ 101067	Magnetic clamp 180N, Ø50mm, zinc-plated, without rubber protection, H=10mm, bore Ø8.5mm
✓ 101068	Magnetic clamp 180N, Ø66mm, rubberized, H=8.5mm, M6 thread
✓ 101069	Magnetic clamp 110N, 43×31mm, rubberized, H=6mm, 2×M4 thread
✓ 109212	Wing screw plastic, M5×10mm

Rod



Item no. 106563

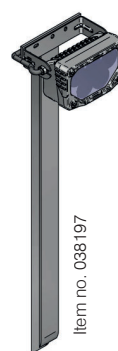

Item no. 038197

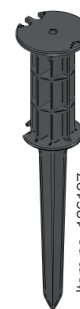

Item no. 126197

Item no.	Designation
106563	Rod round V2A, Ø30, l=600mm incl. mounting material
✓ 038197	Rod T-profile V2A, 30×30×3mm, l=505mm for SpotLED
✓ 126197	Rod moulded part PA6/GF, l=280mm

✓ From stock, offer subject to prior sale

SpotLED 230



SpotLED 230 on rod

The SpotLED 230 is used for a modern and effective lighting; in the outdoor area for gardens, facades, lighting of advertising panels, etc. In the interior used f.ex. for the room illumination (also indirectly) for workshops, workplaces, etc. mobile or fix installed. The spotlight can be operated in combination with a motion detector.

Features

- robust housing made of die cast aluminum, powder-coated gray
- bracket made of stainless steel, powder-coated gray
- works perfect even at low temperatures, no flickering
- resistant to vibrations

Technical Data

Operating voltage:	230VAC/DC (+/-10%)
System performance:	17 W
Luminous flux:	1'200 lm
Light efficiency:	70 lm/W
Light temperature:	
-	approx. 4'000K (comfort white)
-	approx. 6'000K (cool white)
Colour rendering index:	
-	4'000K Ra >75
-	6'000K Ra >70
Operating life:	> 50'000 h
Material housing:	aluminium
Housing colour:	gray
Cover:	2 mm polycarbonate
Protection category:	IP66
Protection class:	I
Temperature range:	-30°C to +50°C
Dimensions (L×W×H):	166×89×76 mm
Weight:	approx. 1.4 kg (incl. cable)

Dimensions

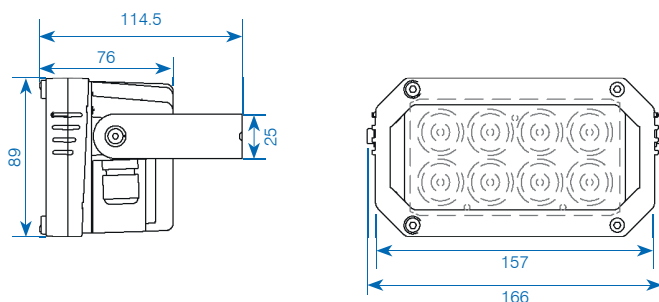

Over temperature protection

Temperature of the LEDs is monitored. If temperature reaches a specified maximum LED temperature, brightness will be automatically reduced. If temperature decreases under the maximum specified LED temperature brightness will be adjusted to the set value.

Dimming

The spotlight can be dimmed with most of common phase angle control dimmers.

Light Colours

Standard light colours are cool white (approx. 6'000 K) and comfort white (approx. 4'000 K).

Optics

3 different, optics Spot, Medium and Wide are available.

Types of mounting

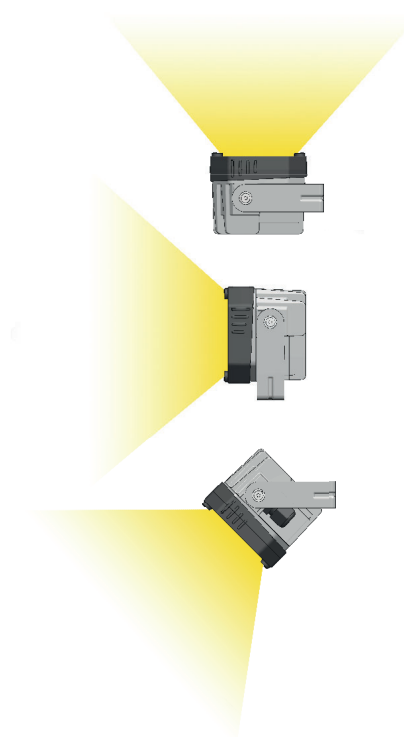



SpotLED 230 as outside illumination of municipal buildings



SpotLED 230V facade lighting

Comfort white approx. 4'000K

- ✓ 860169 SpotLED 230-17W, 4'000K, Spot, IP66
incl. feed-in cable black 5m, 3×1mm² T12
- ✓ 860170 SpotLED 230-17W, 4'000K, Medium, IP66
incl. feed-in cable black 5m, 3×1mm² T12
- ✓ 860171 SpotLED 230-17W, 4'000K, Wide, IP66
incl. feed-in cable black 5m, 3×1mm² T12

Cool white approx. 6'000K

- ✓ 860172 SpotLED 230-17W, 6'000K, Spot, IP66
incl. feed-in cable black 5m, 3×1mm² T12
- ✓ 860173 SpotLED 230-17W, 6'000K, Medium, IP66
incl. feed-in cable black 5m, 3×1mm² T12
- ✓ 860174 SpotLED 230-17W, 6'000K, Wide, IP66
incl. feed-in cable black 5m, 3×1mm² T12



SpotLED 230V

For permanent installation, disconnect the plug, bring the cable to the required length and connect it directly.

Accessories/spare parts

- ✓ 110743 Pedestal complete for SpotLED 230
incl. wingnuts, spacers, protective caps
- 110922 Wing screw plastic, M5×25mm for SpotLED 230
- 111096 Protective caps plastic for holderprotection SpotLED 230
- ✓ 126197 Rod moulded part PA6/GF, l=280mm

Special features

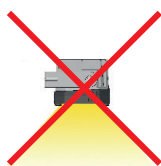

This type of mounting is not suitable for outdoor areas (pressure compensation seal).

- ✓ From stock, offer subject to prior sale



SpotLED 230V Indoor riding arena

ApolloLED 2N



IP44



This product is used for the mobile illumination of large areas and/or intensive spatial lighting. Many uses also include the illumination of sports areas, such as ski slopes/cross-country ski trails and similar.

Features light

- light all around at higher light point
- glass guard is protected by smaller diameter
- replacement of heat loss: The fan sucks the ambient air and generates an airflow through the lamp
- the air in- and outlet are at the bottom of the lamp
- switchable to 180° radiation

Technical data

Input voltage:	100-277VAC
System performance:	
- 50% illuminated:	220W
- 100% illuminated:	440W
Luminous flux:	53'760lm
Luminaires:	896×0.5W SMD-LED
LED power:	122lm/W
Light colours:	5'000K
CRI:	Ra>80
Operating life:	L70/B10 >50'000h
Protection category:	IP44
Protection class:	I
Operating range of temperature:	-25°C to +45°C
Diameter Ømm:	208mm
Length with suspension device:	900mm
Max. tripod diameter:	38mm
Weight light:	11kg
Mounting height:	3.5m
Illumination area:	>700m ²

Technical data transport case

Is offered completely with flight case.

Length:	1'180mm
Width:	280mm
Height:	300mm
Unladen weight:	8.6kg

Technical data tripod

An appropriate tripod is required to ensure optimum handling.

Height min.:	1'670mm
Height max.:	3'700mm
Diameter of legs extended:	1'280mm
Maximum load:	30kg
Weight:	21.4kg



Item no.	Designation
✓ 246988	ApolloLED 2N, 230V/896×0.5W, incl. power supply 5m 3×1.5mm ² , plug T13, incl. transport case
✓ 800211	ApolloLED 2N, 230V/896×0.5W, excl. power supply and transport case

Accessories/spare parts	
✓ 102009	Tripod, steel chromatised, h=max. 3.7m, with crank winch, max load 30kg, tube ø38mm
✓ 800444	Power supply 5m 3×1.5mm ² , plug T13
800445	Power supply 10m 3×1.5mm ² , plug T13
✓ 330938	Transport case (Flight Case) black



✓ From stock, offer subject to prior sale

ApolloLED ECO



IP44



This product is used for the mobile illumination of large areas and/or intensive spatial lighting. Many uses also include the illumination of sports areas, such as ski slopes/cross-country ski trails and similar.

Features

- very powerful lighting
- robust design - illuminant cannot splinter or break
- the air in- and outlet are at the bottom of the lamp
- operation with permanent forced ventilation for high durability
- also usable as suspended lamp (without tripod)
- over-temperature circuit-breaker with independent reactivation
- full power immediately after switching on
- no preheating time, no cooling time
- operation with integrated power supply unit
- light all around at higher light point

Technical data

Input voltage:	100 - 277 VAC
System performance:	307.5 W
Luminous flux:	32'321 lm
LED power:	100 lm/W incl. fan
Light colours:	5'000 K
CRI:	Ra > 80
Operating life:	L70/B10 > 50'000 h
Protection category:	IP44
Protection class:	I
Operating range of temperature:	-25°C to +50°C
Measurements L x D:	600 x 208 mm
Max. tripod diameter:	38 mm
Weight:	7.5 kg
Utilisation height:	2.7 m
Illumination area:	> 600 m ²

Technical data transport bag

Is offered completely with transport bag.

Dimensions (L x D):	650 x 210 mm
Weight:	0.3 kg

Technical data tripod

An appropriate tripod is required to ensure optimum handling.

Height min.:	1'670 mm
Height max.:	3'700 mm
Diameter of legs extended:	1'280 mm
Maximum load:	50 kg
Weight:	9.4 kg

Item no.	Designation
✓ 184857	ApolloLED ECO, 230V, 300W, 32'321 lm incl. feed-in cable 5m 3 x 1.5 mm ² , plug T13, incl. transport bag

Accessories/spare parts	
✓ 184858	Tripod, steel/alu powder-coated, h=max. 2.4 m, with crank winch, max load 50 kg, tube ø 35 mm
184860	Transport bag 650 x 210 mm
184862	Tripod mount 0 - 45°
✓ 800444	Connection cable 5m 3 x 1.5 mm ² , plug T13
800445	Connection cable 10m 3 x 1.5 mm ² , plug T13



Item no. 184860

Item no. 184862

Item no. 184858

✓ From stock, offer subject to prior sale

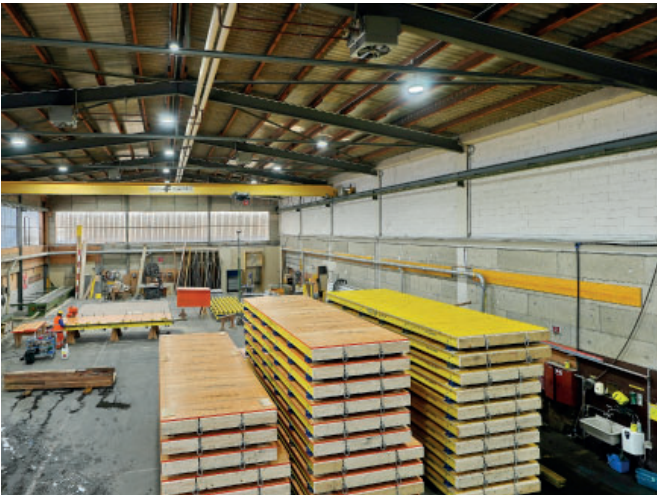

DeltaLUXX Implemia Oberentfelden



BetaLUXX



HPL 1'350W Ski lift Freistadt



ApolloLED ski slope lighting Eischoll



BetaLUXX Implemia Oberentfelden



HPL 900W 1350W Nonner Stadion Bad Reichenhall

PrimaLED LED 2 floodlight



The proven concept of the PRIMA is now available with the innovative LED technology. With this lighting system you benefit from all the LED technology advantages!

The PrimaLED is a technically sophisticated, professional light with excellent light output, low heat generation and low energy consumption.

This working lamp guarantees optimised floodlighting with glare-free, evenly distributed light. It also offers various setup options for any application: hanging, lying or standing!

Product properties

- full light flux available immediately
- low energy consumption with a high light yield
- minimal temperature development
- extremely switching-resistant (> 1 million)
- maintenance-free
- no UV/IR radiation
- yellow housing made from impact-resistant polycarbonate with black rubber edges providing shock and impact protection
- carrying handle also serves as a support which, when engaged, moves the lights to the desired position
- satinated bulb cover made from Makrolon: shock and impact resistant, seals housing to make it water- and dust-proof
- luminaire with reduced surface temperature for a usage in fire risk industrial establishments

Technical data

Operating voltage:	230VAC/24V AC/DC
System performance:	25.2W
Luminous flux:	4'200lm
Light efficiency:	165lm/W
Light temperature:	4'000K
Colour rendering index:	Ra > 80
Operating life:	L70/B10 80'000h
Protection class:	I (230V with socket) II (230V without socket) III (24V) (20-28V AC/DC)
Protection category:	IP65 (without socket) IP54 (with socket)
Impact resistance:	IK08
Power supply:	mains connection
Temperature range:	-20° C to +40° C
Weight:	3.1 kg
Dimensions (W×H×D):	305×295×110mm

✓ From stock, offer subject to prior sale



IP55



230 VAC, with built-in socket

230357	PrimaLED 2, 230V/25.2W, 4'200lm, excl. feed-in cable with built-in socket T13
✓ 228219	PrimaLED 2, 230V/25.2W, 4'200lm, incl. feed-in cable 5m, 3×1.0mm ² , T13 with built-in socket T13
✓ 228220	PrimaLED 2, 230V/25.2W, 4'200lm, incl. feed-in cable 10m, 3×1.0mm ² , T13 with built-in socket T13



IP65



230 VAC, without built-in socket

✓ 228221	PrimaLED 2, 230V/25.2W, 4'200lm, incl. feed-in cable 5m, 2×1.0mm ² , T11 without built-in socket
✓ 228222	PrimaLED 2, 230V/25.2W, 4'200lm, incl. feed-in cable 10m, 2×1.0mm ² , T11 without built-in socket
✓ 870015	PrimaLED 2, 230V/25.2W, 4'200lm, excl. cable, M20, without socket



IP65



24 VAC/DC

210261	PrimaLED 2, 24V/25.2W, 4'200lm, incl. feed-in cable 5m, 2×2.5mm ² , CEE16/2 without built-in socket
210262	PrimaLED 2, 24V/25.2W, 4'200lm, incl. feed-in cable 10m, 2×2.5mm ² , CEE16/2 without built-in socket
✓ 870016	PrimaLED 2, 24V/25.2W, 4'200lm, IP65 without feed-in cable, M20 without built-in socket

Dimensions

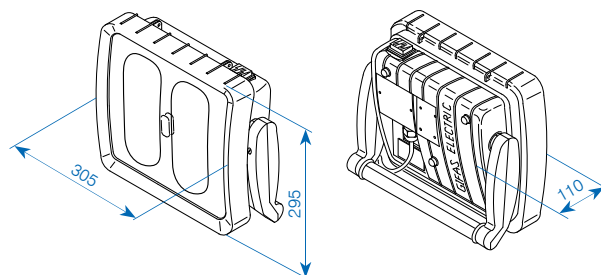



Ceiling mounting
Ceiling bracket (screw fixing):
✓ Item no. 045188

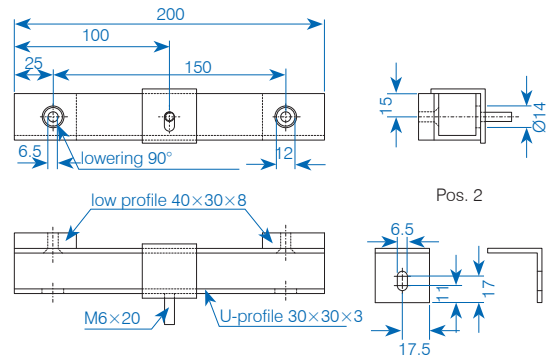

Wall mounting
Wall bracket (screw fixing):
✓ Item no. 045184

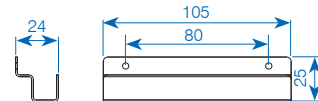

Magnetic holder
Magnetic holder for wall or ceiling mounting:
✓ Item no. 045174

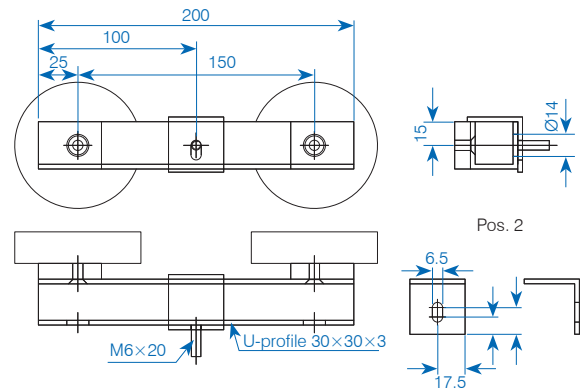

PRIMA with 3-Point-mounting plate V2A, horizontally and vertically adjustable:
Item no. 106193 and 106194

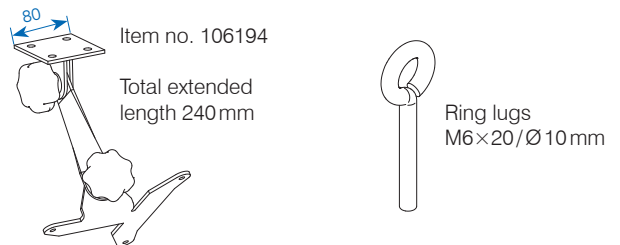

PRIMA panel light finished with 3 ring bolts (for chain, mount etc. provided by customer 3xItem no. 047704)



✓ Item no. 045185

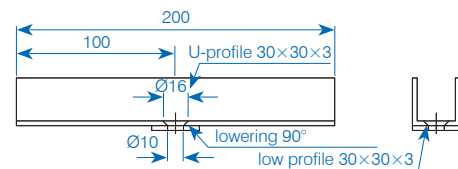

Use on tripod attachment Tripod:
✓ Item no. 010586

Tripod attachment for one lamp:
✓ Item no. 045185

Tripod attachment for two lamps:
✓ Item no. 045187



✓ Item no. 045187

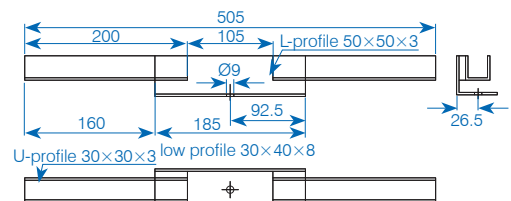

✓ From stock, offer subject to prior sale

AlphaLUXX

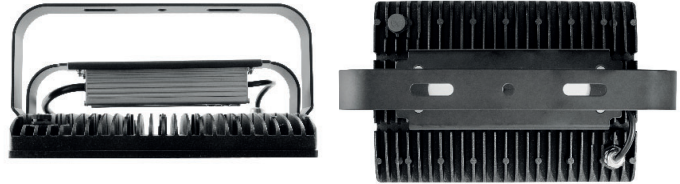

DESIGNED, DEVELOPED and PRODUCED by GIFAS

- hugely efficient at up to 150lm/W
- revolutionary PTFE surface coating
- flexible in terms, light colour and output
- manufactured using top-quality components
- 5-year guarantee

The AlphaLUXX floodlight is **100% Made in Germany**. During the development, great emphasis was placed on the quality of the components, coupled with excellent efficiency.

Individual customer requests regarding performance variants, front panels, supply cable lengths and special colour designs can be realised on request.

Main features

- robust housing made of corrosion-resistant die-cast aluminium (alloy: 230D)
- dirt-resistant PTFE surface coating, suitable for the food industry
- 5mm toughened glass, PC panel also available
- custom-made U-profile seal surrounding all sides
- durable, heat-conducting film for lasting, reliable dissipation of heat from the LED board
- low heat generation thanks to the latest LED technology
- pressure compensation element for extreme temperature fluctuations
- full luminous flux is available instantly after switching on
- low energy consumption with high light output
- maintenance-free
- wide operating temperature range (up to 60°C)
- no UV/IR radiation
- vibration-resistant
- many accessories available from stock

Set up

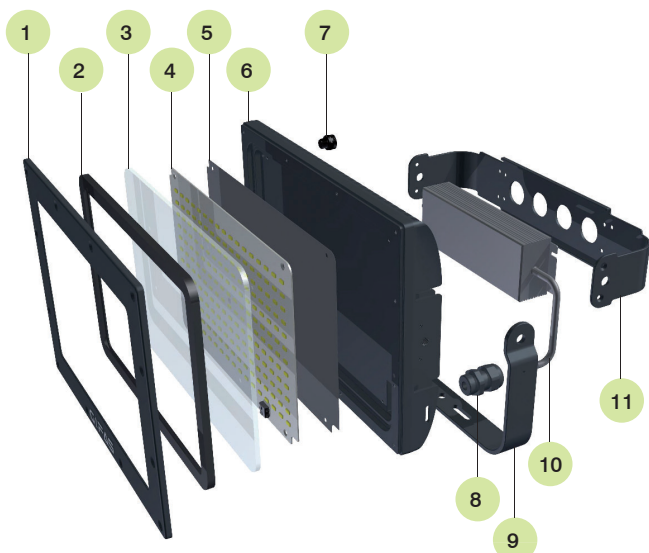

1. Die-cast aluminium frame
2. U-profile silicon seal
3. Front panel (ESG or PC)*
4. LED board
5. Heat conducting film
6. Die-cast aluminium housing
7. Pressure compensation element
8. Screwed cable gland
9. Mounting bracket
10. Power supply
11. Power supply bracket

* ESG = Toughened safety glass
PC = Polycarbonate

AlphaLUXX 25/40/60



Measurements

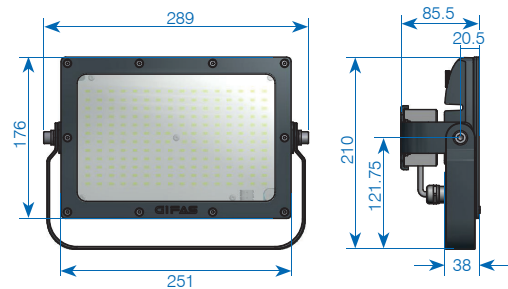

Technical data

Operating voltage:	100 - 277 VAC (50/60 Hz)
System performance:	25.4 W / 40 W / 60 W
Luminous flux frosted glass:	3'365 lm / 5'152 lm / 7'322 lm
Luminous flux clear glass:	7'712 lm
LED power:	132 lm/W / 128 lm/W / 122 lm/W
Light colour:	4'000 K / 5'000 K
Light source:	SMD-LEDs
Colour rendering index:	Ra > 80
Beam angles:	120°
Operating life:	[L70/B10] > 80'000 h
Protection category:	IP65
Protection class:	I
Dimming:	optional DALI
Operating range of temperature:	
- AlphaLUXX 25:	-30° C to +60° C
- AlphaLUXX 40:	-30° C to +55° C
- AlphaLUXX 60:	-30° C to +50° C
Max. surface temperature:	+90° C (suitable for use in industrial premises with fire hazards), D rating label
Cover:	3 mm, (versions available transparent or frosted)
Weight:	approx. 2.7 kg
Measurements (L×W×H):	289×176×85.5 mm
Housing:	Die-cast aluminium
Housing surface:	PTFE-coated, suitable for the food industry
Housing colour:	black
Connection:	1 m connection cable, 3×1.5 mm ² H07RN
Certification:	ENEC, CE suitable for IFS (International Featured Standard)

Light distribution curve

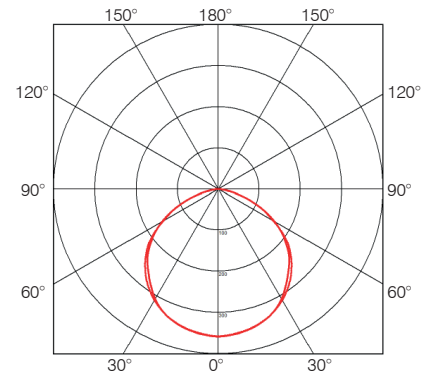

Standard assortment frosted glass

	4'000 K*	5'000 K**	Designation
✓	860962	✓ 860961	AlphaLUXX 25, 100 - 277 VAC, 3'365 lm, IP65 1 m connection cable 1 m, 3×1.5 mm ²
✓	860960	✓ 860959	AlphaLUXX 40, 100 - 277 VAC, 5'152 lm, IP65 1 m connection cable 1 m, 3×1.5 mm ²
✓	860957	✓ 860956	AlphaLUXX 60, 100 - 277 VAC, 7'322 lm, IP65 1 m connection cable 1 m, 3×1.5 mm ²

Special executions

✓	800494	Floodlight AlphaLUXX 60, 5'000 K, dimmable DALI, 230 VAC, clear glass, 1 m cable
---	--------	--

Standard assortment clear glass

	5'000 K**	Designation
✓	860958	AlphaLUXX 60, 230 VAC, 7'712 lm, IP65 1 m connection cable 1 m, 3×1.5 mm ²

* 4'000 K = 4'000 Kelvin, light colour comfort white

** 5'000 K = 5'000 Kelvin, light colour cool white

AlphaLUXX on floor stand

228340	AlphaLUXX 60, 5'000 K, 230 VAC, 7'322 lm, IP65, frosted, connection cable 5 m, 3×1.5 mm ² , T13 mounted of the floor stand
--------	---

Consists of item no. 860956 and 179727.

Accessories AlphaLUXX 25/40/60

✓ 179727	Floor stand ALU, powder coated black for AlphaLUXX 25 - 60
✓ 010586	Tripod standard h=1.5-3.5 m



✓ From stock, offer subject to prior sale

AlphaLUXX 80/100/120



5 YEARS GUARANTEE



IP65



Measurements

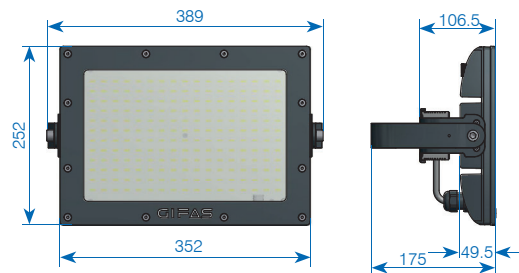

Technical data

Operating voltage:	100-277 VAC (50/60 Hz)
System performance:	86W/111W/128W
Luminous flux clear glass:	12'801 lm/16'432 lm/18'636 lm
Luminous flux frosted glass:	11'540 lm/14'052 lm/16'461 lm
Light efficiency:	150 lm/W/148 lm/W/146 lm/W
Light colour:	4'000 K/5'000 K (3'000 K on request)
Light source:	SMD-LEDs
Colour rendering index:	Ra > 80
Beam angles:	60°/90°/120°
Operating life:	[L70/B10] > 80'000 h
Protection category:	IP65
Protection class:	I
Dimming:	optional DALI
Operating range of temperature:	
– AlphaLUXX 80:	–30° C to +60° C
– AlphaLUXX 100:	–30° C to +55° C
– AlphaLUXX 120:	–30° C to +50° C
Max. surface temperature:	+90° C (suitable for use in industrial premises with fire hazards), D rating label
Cover:	toughened glass, 5 mm (versions available transparent or frosted) optional PC, impact-resistant plastic cover, 5 mm
Weight:	approx. 7.0 kg
Measurements (L×W×H):	389×252×106.5 mm
Housing:	Die-cast aluminium
Housing surface:	PTFE-coated (suitable for the food industry)
Housing colour:	black
Connection:	1 m connection cable, 3×1.5 mm ² H07RN
Certification:	ENEC, CE, suitable for IFS (International Featured Standard)

Other versions on request (e.g. 3'000 K, ball-impact resistant according to DIN VDE 0710-13)

Accessories AlphaLUXX 80/100/120

✓ 169080	Wall-/roof mounting bracket for two AlphaLUXX, V2A stainless steel
✓ 169754	Front glass frosted for AlphaLUXX 80-120
✓ 174345	Floor stand aluminium, powder coated black for AlphaLUXX 80-120

✓ From stock, offer subject to prior sale

Light distribution curve

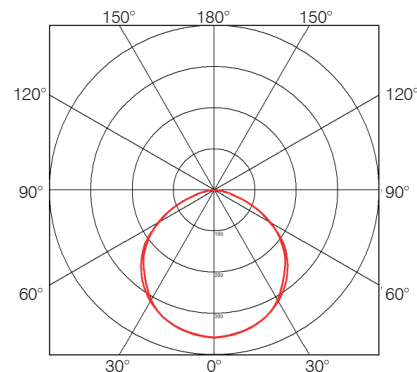

Standard range clear glass and frosted glass

Clear glass		Frosted glass		Designation
4'000 K*	5'000 K**	5'000 K**		
✓ 860965	✓ 860964	✓ 860963		AlphaLUXX 80, 230 VAC, IP65, connection cable 1 m 3×1.5 mm ²
✓ 860968	✓ 860967	✓ 860966		AlphaLUXX 100, 230 VAC, IP65, connection cable 1 m 3×1.5 mm ²
✓ 860973	✓ 860972	✓ 860969		AlphaLUXX 120, 230 VAC, IP65, connection cable 1 m 3×1.5 mm ²

* 4'000 K = 4'000 Kelvin, light colour comfort white

** 5'000 K = 5'000 Kelvin, light colour cool white

Special executions

800480	Floodlight AlphaLUXX 120, 5'000 K, dimmable DALI, 230 VAC, clear glass, 1 m cable
✓ 860970	AlphaLUXX 120, for International Food Standard, glass polycarbonate, 230 VAC, 5'000 K, 18'636 lm, IP65, connection cable 1 m, 3×1.5 mm ²
✓ 800069	AlphaLUXX 120, for motor vehicle sector, 20-48 VDC, clear glass, 5'000 K, 18'636 lm, IP65, connection cable 5 m, 2×2.5 mm ²

AlphaLUXX «mobile»



5 YEARS
GUARANTEE



IP65



Measurements

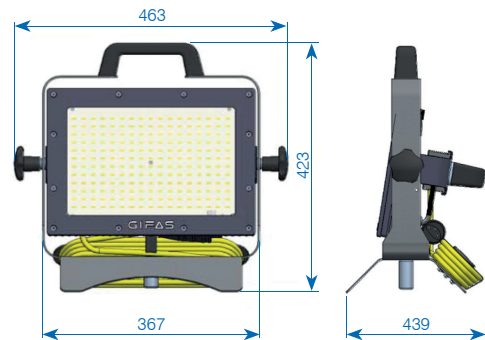

Technical data

Operating voltage:	100 - 277 VAC (50/60 Hz)
System performance:	128 W
Luminous flux:	18'636 lm
Light efficiency:	146 lm/W
Light colour:	5'000 K
Light source:	SMD-LEDs
Colour rendering index:	Ra > 80
Beam angles:	120°
Operating life:	> 80'000 h
Protection category:	IP65
Protection class:	I
Operating range of temperature:	-30°C bis +50°C
Max. surface temperature:	+90°C (suitable for use in industrial premises with fire hazards), D rating label
Cover:	toughened glass, 5 mm (versions available transparent) optional PC, impact-resistant plastic cover, 5 mm
Weight:	approx. 7.0 kg
Measurements (L×W×H):	463×423×439 mm
Housing:	Die-cast aluminium
Housing surface:	PTFE-coated
Housing colour:	black
Connection:	1 m connection cable, 3×1.5 mm ² H07RN
Certification:	ENEC, CE suitable for IFS (International Featured Standard)

Other versions on request.

The high-power AlphaLUXX spotlight is delivered with a standard mounting bracket. For optimal use in different applications GIFAS developed a stand with mounting plug. This allows a simple and quick installation on a tripod. The stand also provides a second benefit by simply being able to be placed on the floor.

The angle of the AlphaLUXX can be adjusted later-ally using two star knobs. In addition, an integrated cable drum for the cable prevents any tripping hazard.













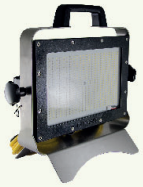

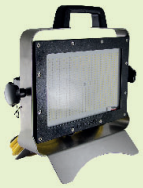

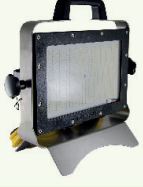

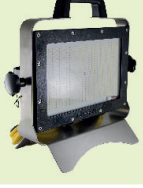

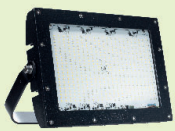

AlphaLUXX «mobile» on tripod
(Item no. 228207/102009)

AlphaLUXX «mobile» with frame (prepared for tripod)

Item no.	Designation
228178	AlphaLUXX 120, with frame V2A IP65, connection cable 8 m 3×1.5 mm ² T13
✓ 228207	AlphaLUXX 120, with frame V2A IP65, connection cable 5 m 3×1.5 mm ² T13

✓ From stock, offer subject to prior sale

Overview of combination possibilities of Alpha-LUXX on tripod

AlphaLUXX – mobile spotlight complete including stand	tripod	adapter
 <p>✓ Item no. 228207</p>	<p>Ø 24 mm</p> <p>Tripod existing army, civil protection</p> <p>by customer</p> 	<p>Not necessary (plug Ø 24 mm fits on stand)</p>
 <p>✓ Item no. 228207</p>	<p>Ø 30 mm</p> <p>Tripod zinc-plated, Heavy execution (for uneven ground)</p> <p>✓ Item no. 190592</p> 	<p>Sleeve Ø 31 mm for tripod Ø 30 mm</p> <p>Aluminium adaptor sleeve with star knob</p> <p>✓ Item no. 172383</p> 
 <p>✓ Item no. 228207</p>	<p>Ø 38 mm</p> <p>Tripod steel with crank handle</p> <p>✓ Item no. 102009</p> 	<p>Sleeve Ø 40 mm for tripod Ø 38 mm</p> <p>Aluminium adaptor sleeve with star knob</p> <p>✓ Item no. 172384</p> 
 <p>✓ Item no. 228207</p>	<p>Ø 30 mm</p> <p>Tripod zinc-plated, version «Fire brigade»</p> <p>✓ Item no. 172088</p> 	<p>Sleeve Ø 31 mm for tripod Ø 30 mm</p> <p>Aluminium adaptor sleeve with star knob</p> <p>✓ Item no. 172383</p> 
AlphaLUXX – Spotlight standard types	tripod	adapter
 <p>f.e. ✓ Item no. 860972</p>	<p>Ø 24 mm</p> <p>Tripod existing army, civil protection</p> <p>by customer</p> 	<p>Plug Ø 24 mm for tripod Ø 24 mm</p> <p>Aluminium adaptor plug</p> <p>✓ Item no. 170721</p> 
 <p>f.e. ✓ Item no. 860972</p>	<p>Ø 30 mm</p> <p>Tripod zinc-plated, Heavy execution (for uneven ground)</p> <p>✓ Item no. 190592</p> 	<p>Sleeve Ø 31 mm for tripod Ø 30 mm</p> <p>Aluminium adaptor sleeve with star knob</p> <p>✓ Item no. 172383</p> 
 <p>f.e. ✓ Item no. 860972</p>	<p>Ø 38 mm</p> <p>Tripod steel with crank handle</p> <p>✓ Item no. 102009</p> 	<p>Sleeve Ø 40 mm for tripod Ø 38 mm</p> <p>Aluminium adaptor sleeve with star knob</p> <p>✓ Item no. 172384</p> 
 <p>f.e. ✓ Item no. 860972</p>	<p>Ø 30 mm</p> <p>Tripod zinc-plated, version «Fire brigade»</p> <p>✓ Item no. 172088</p> 	<p>Sleeve Ø 31 mm for tripod Ø 30 mm</p> <p>Aluminium adaptor sleeve with star knob</p> <p>✓ Item no. 172383</p> 

✓ From stock, offer subject to prior sale



Production AlphaLUX



Illumination AlphaLUX on a stand



Illumination AlphaLUX ARA Morgental



Illumination AlphaLUX



Illumination AlphaLUX ARA Morgental



Illumination AlphaLUX during firefighter

DeltaLUXX



5 YEARS
GUARANTEE



IP65



Measurements

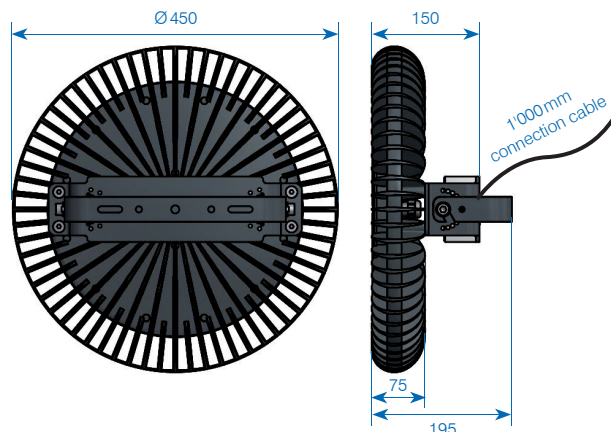

Technical data

Operating voltage:	100 - 277 VAC (50/60 Hz)
System performance:	95 - 270 W
Luminous flux:	16'400 - 40'230 lm
Light colour:	5'000 K
Light source:	SMD-LEDs
Colour rendering index:	Ra > 80
Beam angles:	~30° / ~60° / ~120°
LED-Operating life:	[L70/B10] > 80'000 h
Protection category:	IP65
Protection class:	I
Dimming:	optional DALI
Operating range of temperature	
- 90 - 170:	-30°C to +60°C
- 200:	-30°C to +55°C
- 240 - 250:	-30°C to +50°C
Max. surface temperature:	+90°C (suitable for use in industrial premises with fire hazards), D rating label
Cover:	3 mm toughened glass (Vision) or 3 mm polycarbonate
Weight:	approx. 9.5 kg
Measurements (Ø×H):	450×195 mm
Housing:	Die-cast aluminium
Housing surface:	PTFE-coated
Housing colour:	black
Certification:	ENEC, CB, CE, D rating label

Properties

- robust housing made of corrosion-resistant die-cast aluminium
- dirt-resistant PTFE surface coating
- front panel (toughened safety glass) or polycarbonate
- custom-made U-profile seal surrounding all sides
- durable, heat-conducting film for lasting reliable dissipation of heat from the LED board
- low heat generation thanks to the latest LED technology
- full luminous flux is available instantly after switching on
- low energy consumption with high light output
- maintenance-free
- wide operating temperature range (up to +60°C)
- no UV/IR radiation
- vibration-resistant
- many accessories available from stock
- various light dispersion characteristics available
- 1'000 mm connection cable

Other versions on request (e.g. 3'000 K, 4'000 K).

Set up



1. Die-cast aluminium frame
2. U-profile silicon seal
3. Front panel (toughened safety glass)
4. Optics
5. LED board
6. Heat conducting film
7. Die-cast aluminium housing
8. Screwed cable gland with pressure compensation function
9. Power supply
10. Power supply bracket
11. Mounting bracket

Range/Light distribution

~30° beam angles

Item no.	Designation
800161	DeltaLUXX 150, 230VAC, 5'000K, 17'089lm, ESG beam angles 30°, IP65, connection cable 1'000mm
800163	DeltaLUXX 240, 230VAC, 5'000K, 24'418lm, ESG beam angles 30°, IP65, connection cable 1'000mm

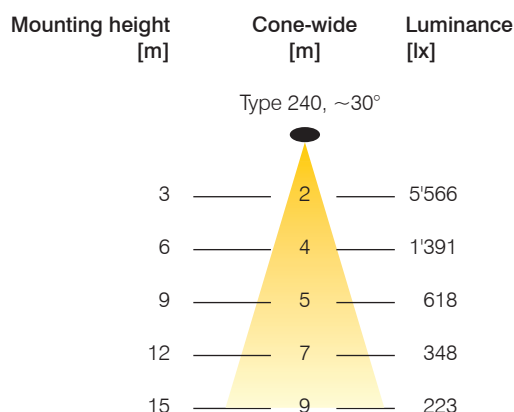

~60° beam angles

Item no.	Designation
800406	DeltaLUXX 2 130, 230VAC, 5'000K, 21'400lm, PC beam angles 60°, IP65, connection cable 1'000mm
800409	DeltaLUXX 2 250, 230VAC, 5'000K, 40'230lm, PC beam angles 60°, IP65, connection cable 1'000mm

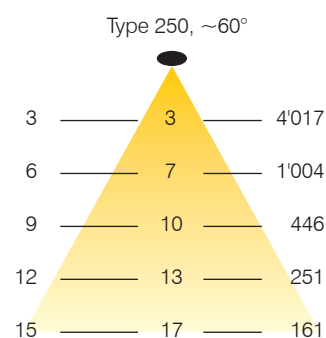

~120° beam angles

Item no.	Designation
800288	DeltaLUXX 2 90, 230VAC, 5'000K, 16'400lm, ESG beam angles 120°, IP65, connection cable 1'000mm
✓ 800290	DeltaLUXX 2 130, 230VAC, 5'000K, 22'400lm, ESG beam angles 120°, IP65, connection cable 1'000mm
✓ 800292	DeltaLUXX 2 170, 230VAC, 5'000K, 28'100lm, ESG beam angles 120°, IP65, connection cable 1'000mm
✓ 800839	DeltaLUXX 2 170, 230VAC, 5'000K, 28'100lm, DALI, ESG beam angles 120°, IP65, connection cable 1'000mm
✓ 800294	DeltaLUXX 2 200, 230VAC, 5'000K, 32'400lm, ESG beam angles 120°, IP65, connection cable 1'000mm
✓ 800296	DeltaLUXX 2 250, 230VAC, 5'000K, 38'900lm, ESG beam angles 120°, IP65, connection cable 1'000mm
✓ 800302	DeltaLUXX 2 250, 230VAC, 5'000K, 38'900lm, DALI, ESG beam angles 120°, IP65, connection cable 1'000mm

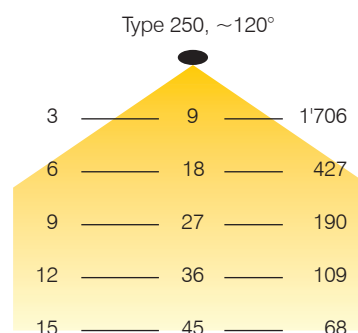

Accessories/spare parts

✓ 179113	Safety cable 1.0m, anti-fall protection for DeltaLUXX
✓ 168467	Plug and socket (plug/box) 2P+PE, IP68, (TeeTube)
✓ 187707	Wall mounting bracket, aluminium, black for DeltaLUXX 150-240W

✓ From stock, offer subject to prior sale

Wide area lighting system HPL 450 W

Wide area lighting system HPL 900 W



Item no. 861033



Item no. 861034



Item no. 861002



Technical Data

Operating voltage:	100 - 240 VAC
LED power:	450 W
System performance:	460 W
LED efficiency:	146 lm/W
Incide of CRI:	Ra > 70
Operating life:	L80/B50 > 97'000 h
LED switching capability:	> 1 mil
Protection category:	IP66
Impact resistance:	IK10
Protection class:	I
MacAdam:	3-step
Dimmable:	Yes
Operating range of temperature:	-20° C to +50° C
Integrated thermal management:	Yes
Max. surface temperature:	+90° C (suitable for use in industrial premises with fire hazards), D rating label
Weight:	19.2 kg
Dimensions l x h* x w:	390 x 685 x 240 mm
Material housing:	Aluminium
Housing colour:	black
Connection:	0.8 m connection cable, with a plug and socket connection
Swivel angle of bracket:	270°

*h = with bracket folded downwards

Dimensions

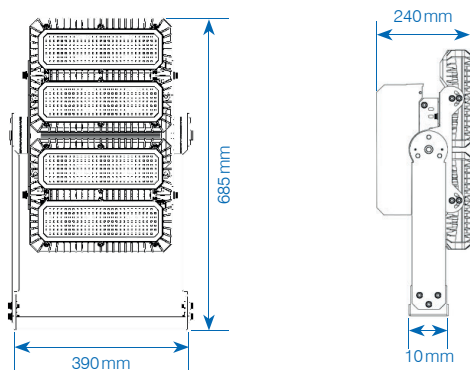

Item no.	Designation
✓ 861033	Wide area lighting system HPL 450W, 230 VAC 110° , 5'700 K, 57'000 lm, IP66, DALI
✓ 861034	Wide area lighting system HPL 450W, 230 VAC, asymmetrical 130° x 60° , 5'700 K, 68'600 lm, IP66, DALI

✓ From stock, offer subject to prior sale

Technical Data

Operating voltage:	100 - 240 VAC
LED power:	900 W
System performance:	920 W
LED efficiency:	146 lm/W
Incide of CRI:	Ra > 70
Operating life:	L80/B50 > 97'000 h
LED switching capability:	> 1 mil
Protection category:	IP66
Impact resistance:	IK10
Protection class:	I
MacAdam:	3-step
Dimmable:	Yes
Operating range of temperature:	-20° C to +50° C
Integrated thermal management:	Yes
Max. surface temperature:	+90° C (suitable for use in industrial premises with fire hazards), D rating label
Weight:	33.3 kg
Dimensions l x h* x w:	700 x 685 x 240 mm
Material housing:	Aluminium
Housing colour:	black
Connection:	0.8 m connection cable, with a plug and socket connection
Swivel angle of bracket:	270°

*h = with bracket folded downwards

Dimensions

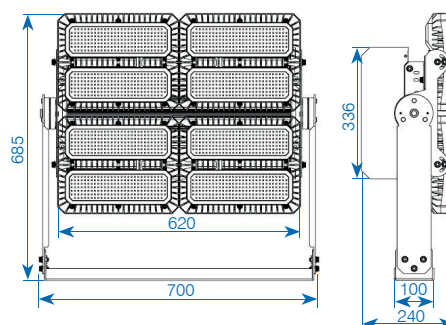

Item no.	Designation
✓ 861002	Wide area lighting system HPL 900W, 230 VAC, asymmetrical 130° x 40° , 5'700 K, 134'000 lm, IP66, DALI

60° version available on request.

Wide area lighting system HPL 1350 W



Item no. 861004



IK10

IP66



Technical Data

Operating voltage:	100 - 240 VAC
LED power:	1'350 W
System performance:	1'380 W
LED efficiency:	146 lm/W
Incide of CRI:	Ra > 70
Operating life:	L80/B50 > 97'000 h
LED switching capability:	> 1 mil
Protection category:	IP66
Impact resistance:	IK10
Protection class:	I
MacAdam:	3-step
Dimmable:	Yes
Operating range of temperature:	-20° C to +50° C
Integrated thermal management:	Yes
Max. surface temperature:	+90° C (suitable for use in industrial premises with fire hazards), D rating label
Weight:	42.8 kg
Dimensions l×h×w:	700×890×240 mm
Material housing :	Aluminium
Housing colour:	black
Connection:	0.8 m connection cable, with a plug and socket connection
Swivel angle of bracket:	270°

*h = with bracket folded downwards

Dimensions

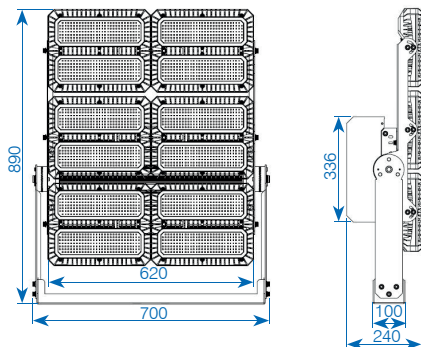

Accessories/spare parts

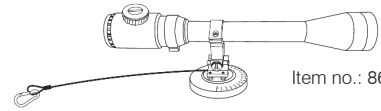

Item no.: 860846

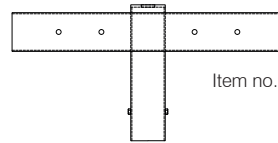

Item no.: 860847

Product features

Modular LED light with symmetrical or asymmetrical lighting characteristics and Single LED technology. The HPL has a low-profile construction and is black powder-coated. It is provided with a 0.8m feed-in cable with a plug and socket connection for easy assembly.

- immediate full luminous flux
- low power consumption at very high light efficiency
- minimal temperatures progression
- high switching capability (> 1 mil)
- large operating temperature range: -20° C to +50° C
- no UV/IR radiation
- insensible against shocks and vibrations

Areas of application

Suitable for all areas which require extensive basic illumination.

- building site
- ski slope
- open spaces
- Industry ...

Available beam angles

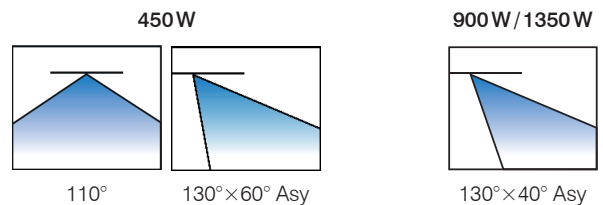

Item no.	Designation
✓ 861004	Wide area lighting system HPL 1'350 W, 230 VAC, asymmetrical 130°x40° , 5'700 K, 197'600 lm, IP66, DALI

60° version available on request.

Accessories/spare parts	
✓ 860846	Alignment device for HPL LED spotlights
860847	Pole mount bracket for pole with Ø 76 mm for HPL 900W/1350W
224414	Pole mount bracket for pole with Ø 76 mm for HPL 450W

✓ From stock, offer subject to prior sale

GET IN TOUCH WITH US

News about the assortment and specific solutions
you can find on our website:

www.gifas.ch

We reserve the right to make technical modifications. V0824

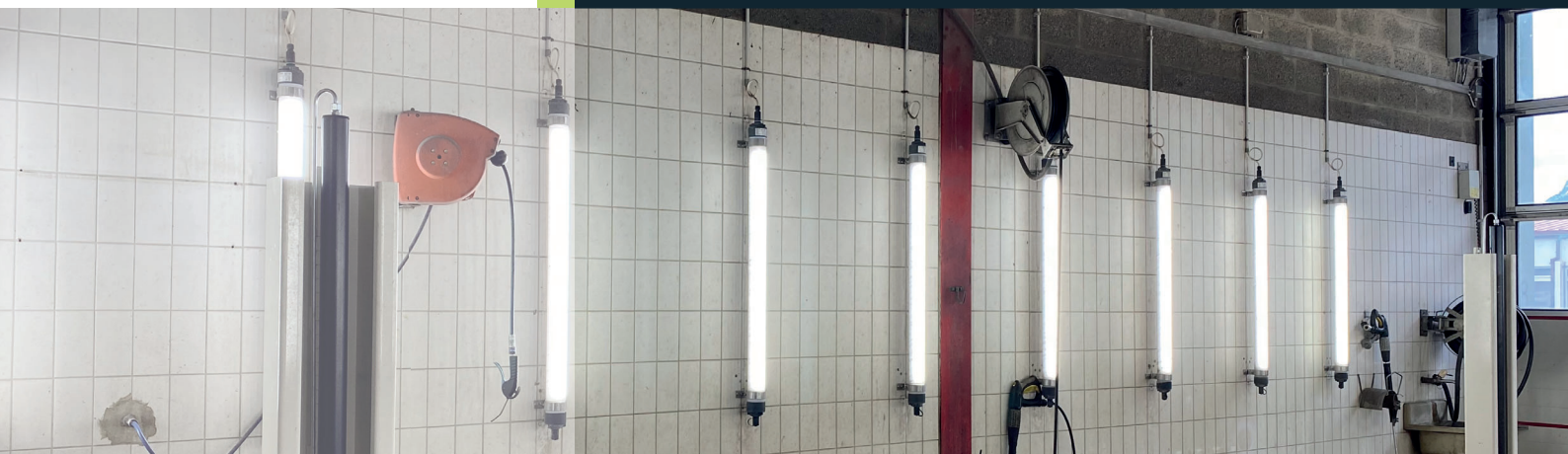

GIFAS
ELECTRIC

GIFAS-ELECTRIC GmbH
Dietrichstrasse 2
CH-9424 Rheineck

+41 71 886 44 44
+41 71 886 44 49
info@gifas.ch
www.gifas.ch